

up-to-date electronics for lab and leisure

ELEKTOR 20

December 1976 40p

Summit

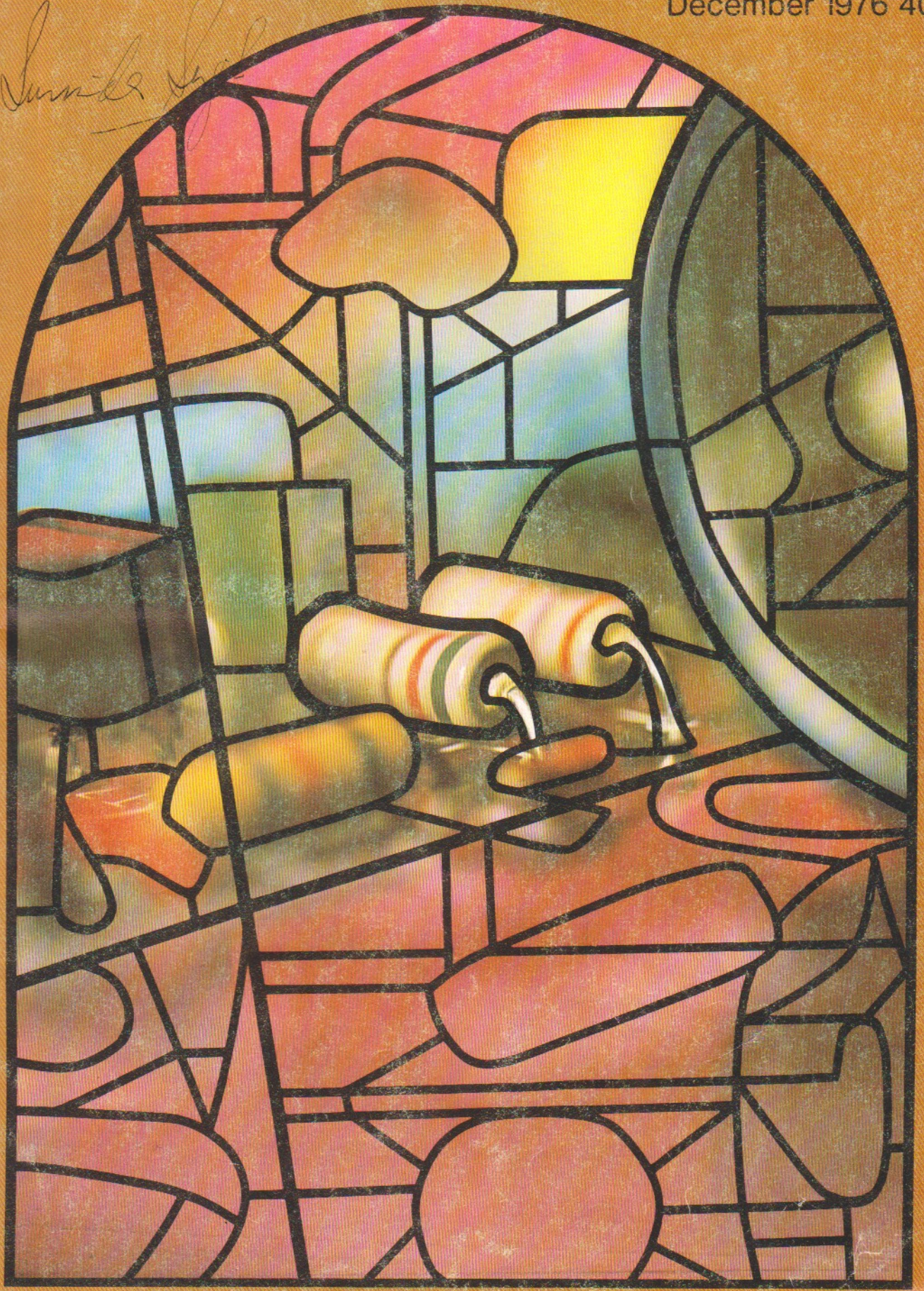

elektor decoder

What is a TUN?
What is 10 n?
What is the EPS service?
What is the TQ service?
What is a missing link?

Semiconductor types

Very often, a large number of equivalent semiconductors exist with different type numbers. For this reason, 'abbreviated' type numbers are used in Elektor wherever possible:

- '741' stands for μ A741, LM741, MC741, MIC741, RM741, SN72741, etc.
 - 'TUP' or 'TUN' (Transistor, Universal, PNP or NPN respectively) stands for any low frequency silicon transistor that meets the specifications listed in Table 1. Some examples are listed below.
 - 'DUS' or 'DUG' (Diode, Universal, Silicon or Germanium respectively) stands for any diode that meets the specifications listed in Table 2.
 - 'BC107B', 'BC237B', 'BC547B' all refer to the same 'family' of almost identical better-quality silicon transistors. In general, any other member of the same family can be used instead. (See below.)
- For further information, see 'TUP, TUN, DUG, DUS', Elektor 20, p. 1234.

Table 1. Minimum specifications for TUP (PNP) and TUN (NPN).

V _{CEO,max}	20V
I _{C,max}	100 mA
f _{hfe,min}	100
P _{Tot,max}	100 mW
f _{T,min}	100 MHz

Some 'TUN's are: BC107, BC108 and BC109 families; 2N3856A, 2N3859, 2N3860, 2N3904, 2N3947, 2N4124. Some 'TUP's are: BC177 and BC178 families; BC179 family with the possible exception of BC159 and BC179; 2N2412, 2N3251, 2N3906, 2N4126, 2N4291.

Table 2. Minimum specifications for DUS (silicon) and DUG (germanium).

	DUS	DUG
V _{R,max}	25V	20V
I _{F,max}	100mA	35mA
I _{R,max}	1 μ A	100 μ A
P _{Tot,max}	250mW	250mW
C _{D,max}	5pF	10pF

Some 'DUS's are: BA127, BA217, BA218, BA221, BA222, BA317, BA318, BA412, BA6Y1, 1N914, 1N4148.

Some 'DUG's are: OA85, OA91, OA95, AA116.

BC107 (-8, -9) families:
BC107 (-8, -9), BC147 (-8, -9), BC207 (-8, -9), BC237 (-8, -9), BC317 (-8, -9), BC347 (-8, -9), BC517 (-8, -9), BC171 (-2, -3), BC182 (-3, -4), BC382 (-3, -4), BC437 (-8, -9), BC414

BC177 (-8, -9) families:
BC177 (-8, -9), BC157 (-8, -9), BC204 (-5, -6), BC307 (-8, -9), BC320 (-1, -2), BC350 (-1, -2), BC557 (-8, -9), BC251 (-2, -3), BC212 (-3, -4), BC512 (-3, -4), BC261 (-2, -3), BC416.

Resistor and capacitor values

When giving component values, decimal points and large numbers of zeros are avoided wherever possible.

The decimal point is usually replaced by one of the following international abbreviations:

p (pico-) = 10^{-12}
n (nano-) = 10^{-9}
 μ (micro-) = 10^{-6}
m (milli-) = 10^{-3}
k (kilo-) = 10^3
M (mega-) = 10^6
G (giga-) = 10^9

A few examples:

Resistance value 2k7: this is 2.7 k Ω , or 2700 Ω .

Resistance value 470: this is 470 Ω .

Capacitance value 4p7: this is 4.7 pF, or 0.000 000 004 7 F.

Capacitance value 10 n: this is the international way of writing 10,000 pF or .01 μ F, since 1 n is 10^{-9} farads or 1000 pF.

Mains voltages

No mains (power line) voltages are listed in Elektor circuits. It is assumed that our readers know what voltage is standard in their part of the world! Readers in countries that use 60 Hz should note that Elektor circuits are designed for 50 Hz operation. This will not normally be a problem; however, in cases where the mains frequency is used for synchronisation some modification may be required.

Technical services to readers

— **EPS service.** Many Elektor articles include a lay-out for a printed circuit board. Some — but not all — of these boards are available ready-etched and predrilled. The 'EPS print service list' in the current issue always gives a complete list of available boards.

— **Technical queries.** Members of the technical staff are available to answer technical queries (relating to articles published in Elektor) by telephone on Mondays from 14.00 to 16.30. Letters with technical queries should be addressed to: Dept. TQ.

Please enclose a stamped, self addressed envelope; readers outside U.K. please enclose an IRC instead of stamps.

— **Missing link.** Any important modifications to, additions to, improvements on or corrections in Elektor circuits are generally listed under the heading 'Missing Link' at the earliest opportunity.

ELEKTOR

Volume 2
Number 12

Editor : W. van der Horst
Deputy editor : P. Holmes
Technical editors : J. Barendrecht
G.H.K. Dam
E. Krempelsauer
G.H. Nachbar
Fr. Scheel
K.S.M. Walraven
Art editor : C. Sinke
Subscriptions : Mrs. A. van Meyel

UK editorial offices, administration and advertising:
6 Stour Street, Canterbury CT1 2XZ.
Tel: Canterbury (0227) — 54430.
Telex: 965504.

Bank: Midland Bank Ltd Canterbury A/C no. 11014587,
Sorting code 40-16-11, giro. no. 3154254.

Assistant Manager and Advertising : R.G. Knapp
Editorial : T. Emmens

Elektor is published monthly on the third Friday of each month, price 40 pence.

Please note that number 15/16 (July/August) is a double issue, 'Summer Circuits', price 80 pence.

Single copies (including back issues) are available by post from our Canterbury office to UK addresses and to all countries by surface mail at £ 0.55.

Single copies by air mail to all countries are £ 0.90.

Subscriptions for 1977 (January to December inclusive): to UK addresses and to all countries by surface mail: £ 6.25, to all countries by air mail £ 11,—. All prices include p & p.

Change of address. Please allow at least six weeks for change of address. Include your old address, enclosing, if possible, an address label from a recent issue.

Letters should be addressed to the department concerned: TQ = Technical Queries; ADV = Advertisements; SUB = Subscriptions; ADM = Administration; ED = Editorial (articles submitted for publication etc.); EPS = Elektor printed circuit board service. For technical queries, please enclose a stamped, addressed envelope.

The circuits published are for domestic use only. The submission of designs or articles to Elektor implies permission to the publishers to alter and translate the text and design, and to use the contents in other Elektor publications and activities. The publishers cannot guarantee to return any material submitted to them. All drawings, photographs, printed circuit boards and articles published in Elektor are copyright and may not be reproduced or imitated in whole or part without prior written permission of the publishers.

Patent protection may exist in respect of circuits, devices, components etc. described in this magazine. The publishers do not accept responsibility for failing to identify such patent or other protection.

National advertising rates for the English edition of Elektor and/or international advertising rates for advertising at the same time in the English, Dutch and German issues are available on request.

Distribution: Spotlight Magazine Distributors Ltd, Spotlight House 1, Bentwell Road, Holloway, London N7 7AX.

Copyright © 1976 Elektor publishers Ltd — Canterbury.

Printed in the Netherlands.

contents

selektor	1209
thermometer	1212
If one is to keep up with the Joneses — or, better still, beat them to it! — now is the time to install a digital thermometer in the living room. Preferably one using seven-segment LED displays.	
missing link	1218
snooze-alarm-radio-clock	1219
Although most readers of technical magazines will have had a surfeit of digital clocks by now, we feel that the design given here may still be of interest. The integrated circuit (Fairchild type 3817 D) is quite cheap, and it can be used as (snooze) alarm clock, radio alarm clock, stopwatch or time switch, to name a few possibilities. All the components will fit on a single small printed circuit board.	
parking meter alarm — J. Schmitz	1224
In most large towns and cities the parking meter is a very familiar sight. If one is careful parking is still relatively cheap, but if one forgets to get back to the 'mechanical wonder' before it gets hungry again, one runs the risk of making a large donation to the city treasury. By letting you know when your time is just about up, the little unit described here can pay for itself in one go.	
ejektor	1226
Class-B output stages without quiescent current (adjustment).	
drill control	1228
There are two basic types of speed control for electric drills. The most common type simply reduces the power to the drill to obtain a lower speed; this has the disadvantage that the speed of the drill depends on the load. A more sophisticated type uses some form of feedback to hold the speed more or less constant at the required number of revs. The control described here is of the latter type.	
transistors (data)	1231
cumulative index '76'	1232
tup/tun/dug/dus (data)	1234
seven-segment to BCD converter	1235
phasing and vibrato	1236
In this article some applications of the analogue shift register type TDA 1022 are described, including a phasing and vibrato unit.	
Elektorscope (part 1)	1244
The Elektorscope is a dual-trace general purpose oscilloscope for the home constructor. In this design the accent has been placed on reliability, ease of construction and simplicity of operation, rather than on elaborate facilities that will rarely be used and extremely high performance circuits that the home constructor has not the equipment to calibrate. To simplify wiring, the oscilloscope is of modular construction, with Y amplifiers and timebase that plug into a motherboard containing most of the interwiring.	
sirens	1254
Sound effects are always popular. One of the most popular effects for 'livening up' disco-shows, films, etc., is the (police) siren. The crime series on TV have taught practically everybody the difference between the European two-tone siren and the banshee wail of the American version. The circuit described here can produce either sound.	
market	1256

THERMOMETER

Digital displays are becoming quite popular — even though they sometimes consist of little more than numbers painted on a rotating drum. . . This particular type of display is beneath the dignity of the electronics enthusiast, of course.

If one is to keep up with the Joneses — or, better still, beat them to it! — now is the time to install a digital thermometer in the living room. Preferably one using seven-segment LED displays.

It is not at all surprising that digital displays are becoming increasingly popular. Admittedly, there is a certain element of novelty; but the main reason is that they provide a clearly legible display. The thermometer described here is a good example of this: it is much easier to read than the conventional mercury type!

The temperature is displayed in whole numbers of degrees, so the maximum error is $\pm 0.5^\circ$. Originally, the unit was intended for measuring in degrees Centigrade and the measuring range was chosen to suit the domestic environment: $5^\circ \dots 50^\circ\text{C}$ ($41^\circ \dots 122^\circ\text{F}$). However, it is a relatively simple matter to convert it to the Fahrenheit temperature scale. This has the additional advantage that it will then measure to below the freezing point (measuring range $5^\circ \dots 99^\circ\text{F}$), so that it can also be used for measuring the outside temperature. The temperature sensor can be connected to the display unit via almost any length of cable.

The basic principle

The unit consists of three distinct sections (figure 1).

The first is the temperature sensor proper (a silicon diode) with some associated electronics. This is what could be called a 'temperature-to-voltage converter' (block A).



The next step is to convert this voltage into a corresponding number of pulses in a 'voltage-to-frequency converter' (block B). An even better description might be 'voltage-to-pulse-train converter'.

Finally, these pulses are counted and the number of pulses is displayed on two seven-segment LED displays (block C).

Temperature-to-voltage

Either a normal silicon diode or a silicon transistor can be used as temperature sensor. The transistor should be wired as shown in figure 2. In both cases, the voltage drop across the device depends on the temperature. When a constant current is passed through either device,

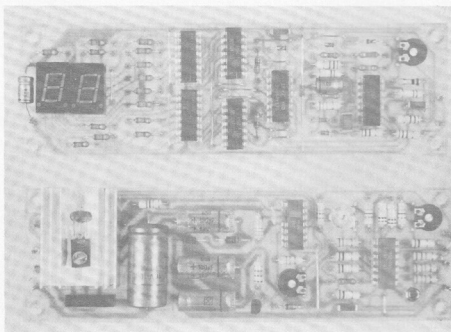
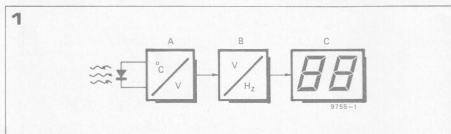

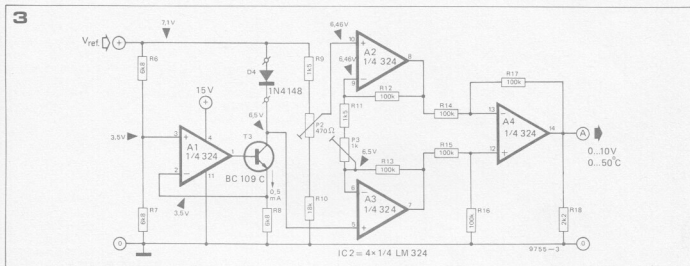
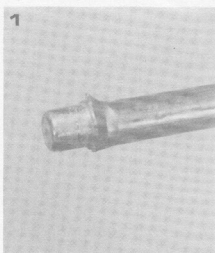
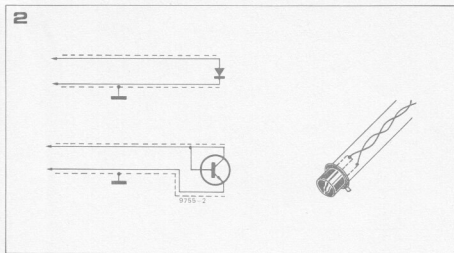

Figure 1. Block diagram of the thermometer. The temperature sensor is a normal silicon diode.

Figure 2. It is also possible to use a silicon transistor as temperature sensor, connected as shown here. If the connection to the rest of the circuit is longer than 2 ft. (50 cm), twin-core screened cable should be used.

Figure 3. The temperature-to-voltage converter. The determining factor for the reliability of the thermometer is the stability of the reference voltage V_{ref} . This voltage (7.1 V) is derived from the very stable voltage reference source in the IC in the power supply.

Figure 4. Conversion characteristic of the temperature-to-voltage converter. The lower limit of the output voltage is determined by the characteristics of the opamps; it cannot go much below 100 mV.

Photo 1. The prototype temperature sensor consisted of a transistor glued into the end of a length of plastic tubing. This makes the unit sufficiently water-tight for use in aquaria or out-of-doors.

the voltage drop varies almost linearly with (absolute) temperature. This means that if the voltage drop corresponding to the first 273°K is subtracted from the total drop, the resulting voltage is proportional to the temperature in degrees Centigrade. Just what the doctor ordered!

This part of the circuit is shown in figure 3. D4 is the sensor — this can be either a diode or a transistor, as mentioned above. As stated earlier, a constant current must be passed through this diode. The first opamp (A1) and transistor T3 are used as a constant current source. A reference voltage is

applied to the non-inverting input of the opamp and the voltage at the emitter of T3 is applied to the inverting input. The circuit will now maintain a constant voltage at the latter point, and since this voltage appears across a constant resistance (R8), the current through the resistor must also be constant. With the component values shown, this current — which also flows through the diode — is fixed at approximately 0.5 mA.

The other three opamps together form a high-performance differential amplifier, the gain of which can be preset with P3. The sensor diode D4 is connected to one input (pin 5 of A3); a constant

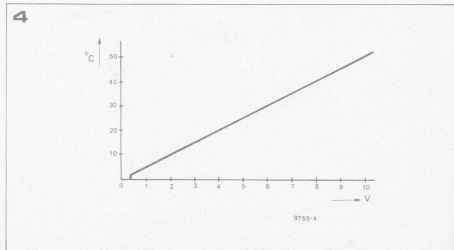

5

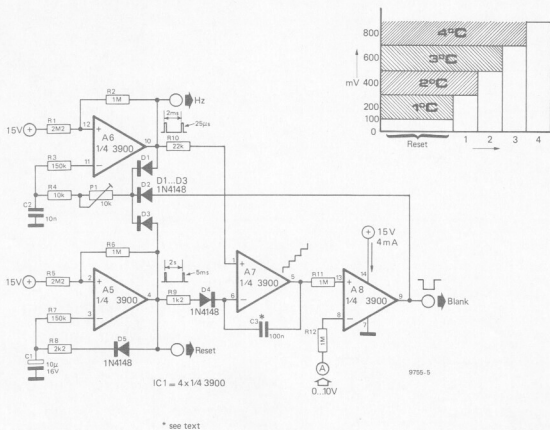

6

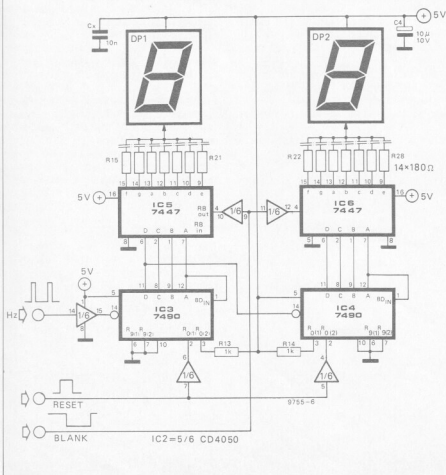
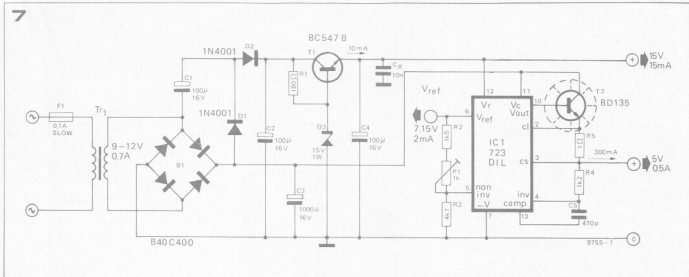

Figure 5. The voltage-to-pulse-train converter. If the unit has been calibrated properly for measuring in degrees Centigrade, the characteristics will be as shown in the graph. No output is produced if the input voltage is below 100 mV; an input voltage between 100 mV and 300 mV corresponds to one pulse at the output; an input between 300 mV and 500 mV gives two pulses; and so on.

Figure 6. The counter and display unit is a standard TTL circuit. CMOS buffers are used for matching the (15 V) outputs of the other circuits to the (5 V) level required here.

Figure 7. The power supply produces three supply voltages: 15 volts for the analogue part of the circuit, 5 volts for the TTL ICs and a very stable 7.1 V reference voltage for the temperature-to-voltage converter.

Photo 2. The complete unit.



voltage, set with P2, is applied to the other input (pin 10 of A2). This second voltage is the drop which corresponds to the first 273° Kelvin. It is now possible to set P2 so that freezing point corresponds to 0 V at the output. If the gain of the opamp is set correctly, a temperature variation of 50°C will correspond to an output voltage variation of 10 V, as shown in figure 4.

Voltage-to-pulse-train

This part of the circuit is shown in figure 5. Its function is to produce a series of pulses, whereby the number of pulses correspond to the output voltage from the preceding circuit.

Each measuring cycle is initiated by a reset pulse from A5. This opamp produces one pulse every 2 seconds, so the final temperature reading is updated at two-second intervals. If required, a different interval can be set by changing the value of C1.

For a proper understanding of the circuit, it is essential to realise that the integrated circuit used here (the LM3900) contains four Norton-type opamps. The input stages of these opamps can be considered as transistors with the emitter connected to supply common. This means that they must be current-driven, and so a resistor is included in series with all the inputs in this circuit.

Each measuring cycle now proceeds as follows. At the moment that the output from A5 becomes 'high', current flows through R9 and D4 into the inverting input of A7, causing its output voltage to drop to almost 0 V. C3 is discharged. Since the output of A7 is now practically zero, the current through R11 will be less than the current through R12 and the output of A8 will also drop to 0 V. This output is used for blanking the display during the reset and count cycle.

After a very short time (5 ms), the output of A5 becomes 'low'. Diodes D2 and D3 are both blocked now, so the second oscillator (A6) is enabled. This multivibrator produces short positive pulses at two-millisecond intervals. The width of the pulses can be set with P1;

they will normally be approximately 25 µs 'wide'.

Each positive pulse from A6 causes a fixed current to flow through R10 for the duration of the pulse. Opamp A7 will drive an identical current through C3 during this period. A fixed current flowing into a capacitor for a fixed period corresponds to a specific voltage rise across the capacitor. This means that the output of A7 will increase in a series of steps: each rise from one level to the next corresponds to one output pulse from A 6 (see figure 8).

When the output from A7 rises above the DC voltage applied to input 'A', the output of opamp A8 will change from zero to almost full supply voltage. This voltage is passed through diode D2 to block the multivibrator.

The result of all this is that a series of pulses appears at the 'Hz' output, the number of pulses being proportional to the voltage at the 'A' input. This pulse train is repeated once every two

seconds. These pulses can be counted and displayed as 'temperature'.

Pulse-train-to-display

The counter and display unit is shown in figure 6. This is a standard TTL circuit. The only unusual feature is the interface: the 15 V outputs from the preceding stage must be converted to the standard 5 V level for TTL. This function is performed by a single CMOS integrated circuit, type CD4050. It contains six buffer stages that are ideal for the purpose, and it has the added advantage that it only requires a single supply voltage (5 volts).

The reset pulse that starts the count cycle in the preceding stage is also used to reset the counters (IC3 and IC4). At the same time, the blanking pulse turns off the display until after the count is completed.

Construction and adjustment

The design itself is not at all critical, so

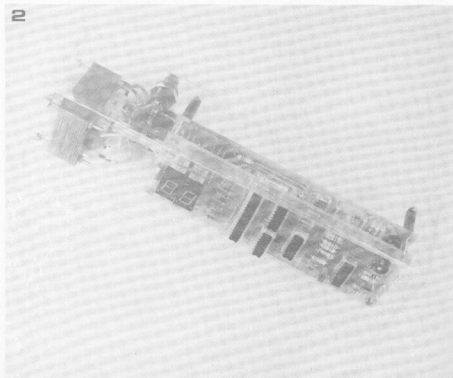

9

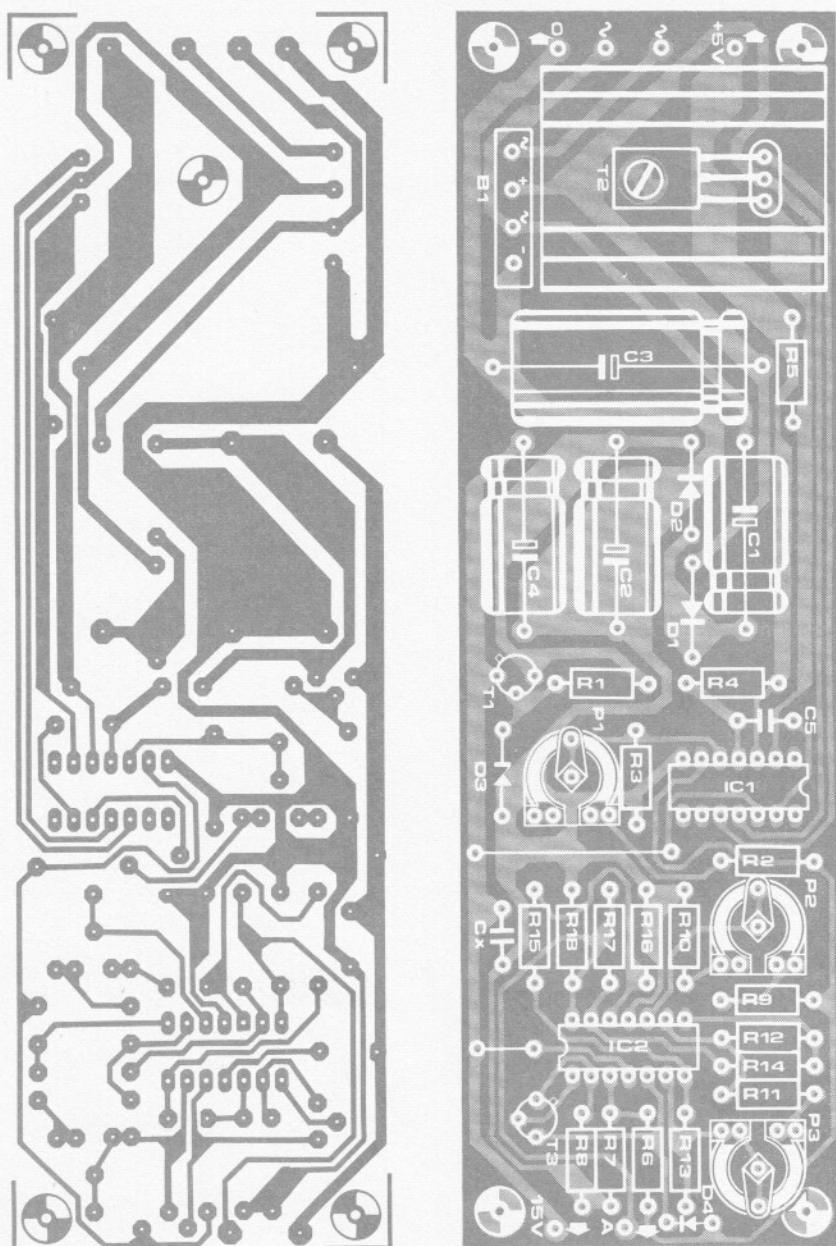

Parts list for figure 9

Resistors:

R1 = 180 Ω
 R2, R9, R11 = 1k5
 R3 = 4k7
 R4 = 1k2
 R5 = 1 Ω
 R6, R7, R8 = 6k8
 R10 = 18 k
 R12 ... R17 = 100 k
 R18 = 2k2
 P1, P3 = 1 k (preset)
 P2 = 470 Ω (preset)

Capacitors:

C1, C2, C4 = 100 μ /16 V
 C3 = 1000 μ /16 V
 C5 = 470 p
 C_x = 10 n

Semiconductors:

D1, D2 = 1N4001
 D3 = 15 V/1 W zener diode
 D4 = 1N4148 or TUN (see text)
 T1 = BC547B, BC107B
 T2 = BD135
 T3 = BC109C
 IC1 = 723 (DIL)
 IC2 = LM324

Sundries:

F1 = 100 mA fuse, slow blow
 Tr1 = 9 ... 12 V/700 mA trafo
 B1 = 40 V/400 mA bridge rectifier
 cooling fin for T2

8

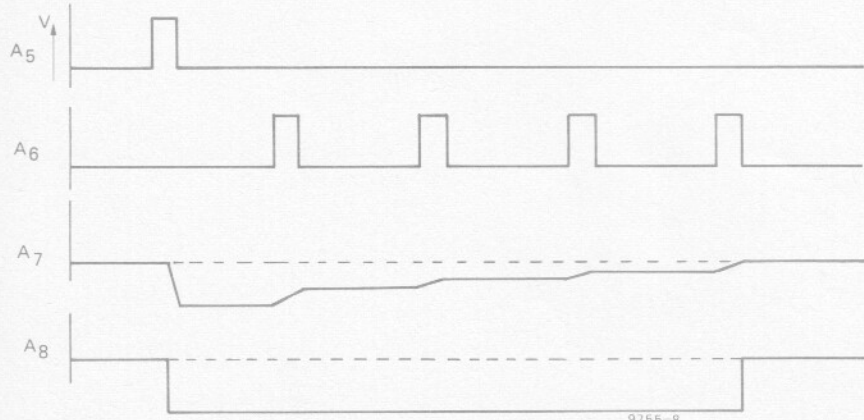

9755-8

the components can be mounted on the board without need for any special precautions.

If the whole unit, including the temperature sensor, is built into a box, care must be taken to ensure that all components that get warm (transformer, power supply and displays) are kept well away from the sensor. However, the sensor does not have to be mounted inside the box. For distances up to one or two feet, twisted wires can be used for the connection; if the distance is greater, twin-core screened cable should be used as illustrated in figure 2.

It is advisable to mount a contrast-enhancing filter in front of the displays. In spite of its long name, this is nothing more than a small sheet of red plastic.

To calibrate the unit, it is best to use a (cheap) multimeter. The procedure is then as follows:

Parts list for figure 10

Resistors:

R1, R5 = 2M2
 R2, R6, R11, R12 = 1 M
 R3, R7 = 150 k
 R4 = 10 k
 R8 = 2k2
 R9 = 1k2
 R10 = 22 k
 R13, R14 = 1 k
 R15 ... R28 = 180 Ω
 P1 = 10 k (preset)

Capacitors:

C1 = 10 μ /16 V
 C2, C_x = 10 n
 C3 = 100 n (see text)
 C4 = 10 μ /10 V

Semiconductors:

D1 ... D5 = 1N4148, DUS
 IC1 = 3900
 IC2 = CD4050
 IC3, IC4 = 7490
 IC5, IC6 = 7447
 DP1, DP2 = common-anode seven-segment display, such as HP5082/7750. For pin-compatible equivalents see Elektor 3, page 451.

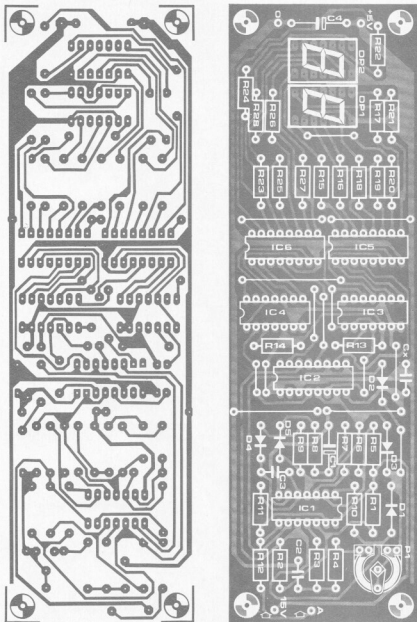

Figure 8. This simplified timing diagram illustrates the operation of the voltage-to-pulse-train converter. Note that neither the output voltages of the opamps nor the time scale are shown in true proportion: the diagram has been 'distorted' for the sake of clarity.

Figure 9. Printed circuit board and component layout for the temperature-to-voltage converter and the power supply (figures 3 and 7). (EPS 9755-1).

Figure 10. Printed circuit board and component layout for the voltage-to-pulse-train converter and the counter/display unit (figures 5 and 6). (EPS 9755-2).

- before switching on for the first time, it is advisable to remove all ICs except IC1 from the circuit. Failing this, start with P1 in the power supply in the mid-position.
- adjust the TTL supply voltage (pin 3 of IC1) to 5 V, using P1. Switch off again, and plug in the other ICs.
- connect the multimeter to the output of A4. Submerge the (insulated!) temperature sensor in a glass containing a mixture of water and ice cubes. Adjust P2 so that the meter just reaches its lowest reading (approximately 0.1 V). The idea is that this adjustment is 'just on the verge': turning P2 even a fraction anti-clockwise should cause a sudden increase of the voltage, whereas turning P2 clockwise should have little or no effect.
- let the temperature sensor warm up to a much higher temperature -

- preferably warm water at 50°C. Adjust P3 until the corresponding voltage is measured: for 50°C this should be 10 V, or for room temperature (20°...22°C) it should be 4.0...4.4 V. This adjustment is not particularly critical - any error will be compensated for further on.
 - finally, adjust P1 on the display board (not the power supply!) so that the display registers the correct temperature.
- If no multimeter is available, it is still possible to calibrate the unit as follows:
- Before switching on, set P1 in the power supply to the mid-position. This should be sufficiently accurate.
 - submerge the sensor in a glass containing a mixture of ice and water, and adjust P2 so that the display just reaches its lowest count (this will usually be either '1' or '2').
 - with P3 in the mid-position, adjust

P1 on the display board so that a higher temperature is correctly indicated.

- the measuring range should now be from just above freezing point to approximately 70°C. If the upper limit differs widely from this (if it is, say, 55°C or 100°C) P3 should be adjusted to a different setting; after the display has been readjusted with P1, the upper limit can be checked again. Repeat this until the upper limit is somewhere between 60°C and 80°C.

If a temperature indication in degrees Fahrenheit is required, the adjustment procedure is rather more complicated:

- first set the TTL supply voltage at 5 V, according to one of the procedures described above.
- increase the value of C3 in the voltage-to-pulse convertor (i.e. near A7) to 150 n or 180 n.
- set P3 in the mid-position and P2 somewhat anti-clockwise from the mid-position. Place the temperature sensor alternately in a glass with ice water and a glass of warm water (at a temperature of 70°...90°F). Allow the reading to stabilise properly after each change of temperature and adjust P1 on the display board until the temperature difference is correctly indicated. For



instance, with the ice water at a temperature of 32°F and the warm water at 82°F, the temperature difference is 50°F. If the indication in the ice water is, say, 45°F, P1 should be adjusted until the reading in the warm water is 95°F.

- place the sensor in the glass containing a mixture of water and ice, and adjust P2 until the display reads 32°F.
- if a multimeter is available, check that the output voltage of A4 is now somewhere between 3 V and 4.5 V (with the sensor still submerged in ice water). If this is not the case, try a different setting of P3 and repeat the whole procedure.
- alternatively, if no multimeter is available, check that the maximum temperature that can be displayed with reasonable accuracy is somewhere between 105° and 125°F. Note that the first digit is not displayed, of course: '110°', is displayed as '10°'. If the maximum temperature is well outside either of these limits, try a different setting of P3 and repeat the whole procedure. ■

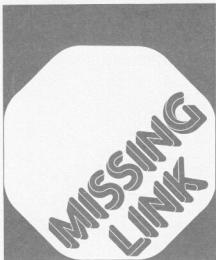

Modifications to
Additions to
Improvements on
Corrections in
Circuits published in Elektor

Albar

November 1976, E19, page 1110

While testing the Albar with several different types of US transducers, it was discovered that by making several minor circuit changes the unit's overall sensitivity can be greatly improved.

Therefore the following changes should be made:

R12 = short circuit connection

D1 = deleted

R3 = 4k7

R4 = 2k2

R6 = becomes a 3.3 mH coil
(Toko 0812-332)

R5 = 1k2 for Murata transducers and 2k7 for Valvo units.

P1 = replaced by a 1 k (lin) pot, mounted on the back panel of the Albar.

R1 = changed to a 220 k or 250 k preset pot.

Adjustments:

Set R1 to mid-range, adjust P1 so there is 2.6 V DC on the emitter of T3.

Monitor this voltage for a few minutes, if it drops away or becomes unstable, lower the resistance of R1. Repeat this process until this voltage is stable.

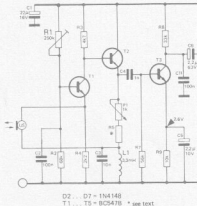

D2 ... D7 = 1N4148
T1 ... T5 = BC347B * see text

Pocketronics

In many of the 'pocketronics' projects in both past and future issues of Elektor, there is a need for a small audio transducer. The Sennheiser HM35, which is usually specified, works very

well but it may be just a little expensive for some people.

An alternative transducer is a cheap ear-phone of the type usually supplied with inexpensive transistor radios. Due to the shape of the air passage these devices don't give much audio power output, however, and if the top is pried off all the pieces fall out. The solution is to apply a small amount of glue to four spots around the outside of the diaphragm. This keeps everything in place and the unit will have a fair audio output. The idea is illustrated in the drawing.

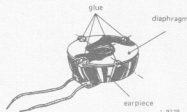

A further point is the impedance required. In the various circuits, several different values are given. In practice any value between about 500 Ω and 1 k will be suitable; in some circuits lower values are also permissible.

Sensitive metal detector

November 1976, E19, page 1116.

It has been discovered that the Murata filter (FL1 = SFD455) can be installed in two different directions on the pcb. Only one way is correct. For correct positioning, Murata put a small 'dot' or bump on the top of the filter's plastic case. This dot should be located at the end of the filter nearest to C1.

Transistor T3 is shown reversed in figure 4. For proper connection, the transistor should be rotated 180°.

The p.c. boards supplied by the EPS service are correct.

It has also been brought to our attention that a license is required when using heterodyne metal detectors inside the UK. Almost every metal detector, including the Elektor design is of the heterodyne type.

Furthermore, operation of metal detectors in the UK is restricted to frequencies between 16 kHz and 150 kHz. This means that the VFO in this design must operate between 45.5 and 136.5 kHz. The search coil dimensions should be adjusted accordingly: the number of turns will have to be drastically increased.

License applications should be made to:

The Home Office
Radio Regulatory Dept
Waterloo Bridge House
Waterloo Road
London SE1.

Pinning BF494

The transistor list in E17, p.947 shows the pinning for the BF494 according to the 'official' Pro-Electron publication. This has proved to be incorrect: the correct pinning is shown in the list on page 1231 in this issue.

SNOOZE-ALARM- RADIO-CLOCK

Although most readers of technical magazines will have had a surfeit of digital clocks by now, we feel that the design given here may still be of interest. The integrated circuit (Fairchild type 3817 D) is quite cheap, and it can be used as (snooze) alarm clock, radio alarm clock, stopwatch or time switch, to name a few possibilities.

All the components will fit on a single small printed circuit board.



The 3817 D has the major advantage that it can drive the display direct — no buffer transistors are required. Either LED or liquid crystal displays can be used; in the design described here, 7-segment LED displays are used, since they are more rugged.

Since the basic principles of a digital clock have already been described many times, this article will only deal with the construction and possible applications of the clock.

The connections to the IC are shown in figure 1, and figure 2 gives the complete circuit diagram. The 50 Hz (or 60 Hz) mains frequency is passed through a simple interference filter (R1/C1) to drive the clock. For 50 Hz operation, pin 36 must be connected to the positive supply; for 60 Hz operation this pin is left floating — an internal

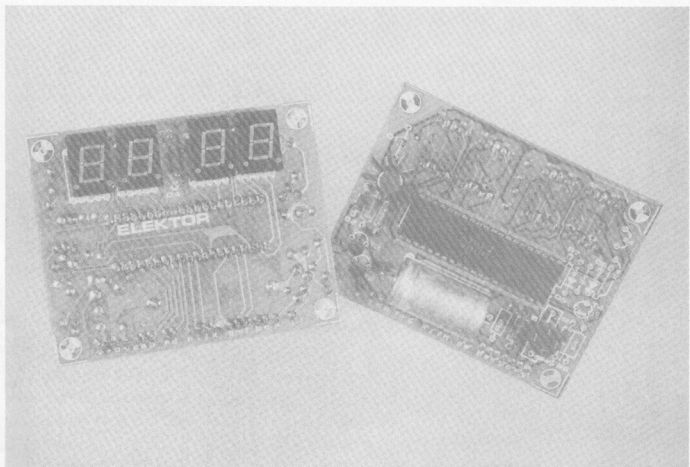

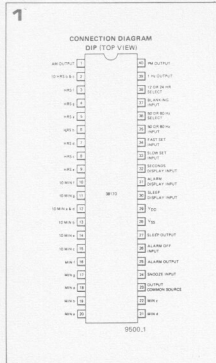

Figure 1. Pinning of the 3817D.

Figure 6. Printed circuit board and component layouts for the clock (EPS 9500). Figures 6a and 6b: copper layout; figures 6c and 6d: 12-hour version with Fairchild FND500 display; figures 6e and 6f: 24-hour version with Hewlett Packard HP5082-7760 display. Note that either type of display can be used for either version.

'pull-down' resistor then holds it at 'low' logic level.

The power supply for the displays is connected to a separate pin on the chip (pin 23). For normal operation, this pin can simply be connected to the same supply as pin 28. However, care must be taken to ensure that the display drivers cannot be overloaded. The maximum dissipation per output is 25 mW and the maximum current is 8 mA. A simple and adequate solution is to drop the excess voltage across a simulated zener diode (T1/D1) in the common cathode return.

Pin 37 can be used for display blanking. The displays are 'on' when this pin is connected to the supply. In this case, there is no 'pull-down' resistor on the chip, so R2 has to be added if the blanking option is required. This option can be useful if the clock is to be run on batteries: the wire link on the board between pin 37 and positive supply is replaced by a pushbutton. Of course it will be necessary to add a crystal timebase or something similar if battery operation is considered.

The clock can be set to run in either a 12-hour or a 24-hour mode. The 12-hours mode is selected by omitting the wire link between pin 38 and the positive supply. The difference between

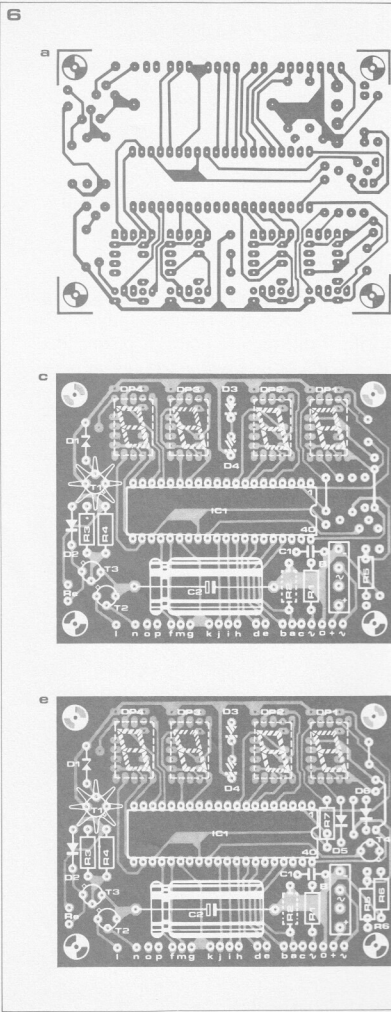

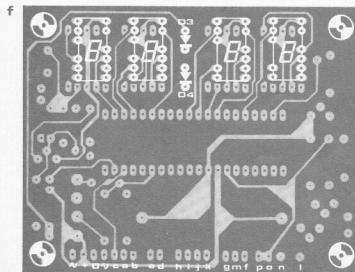
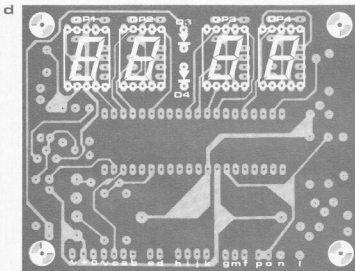
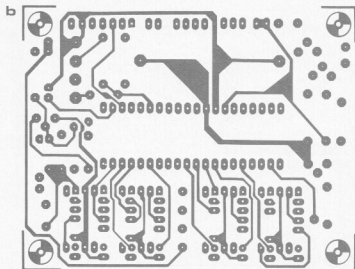

Parts list.

Resistors:

- R1 = 100 k
- R2 = 100 k (only if blanking is required)
- R3 = 4k7
- R4 = 33 k
- R5 = 390Ω (see text)
- R6 = 4k7 (24-hour version only)
- R7 = 270Ω (24-hour version only)

Capacitors:

- C1 = 10 n
- C2 = 1000μ/25 V

Semiconductors:

- T1 = BC141, 2N3553
- T2, T3 = TUN
- T4 = TUP (24-hour version only)
- D1 = 12 V/100 mW zener
- D2 = 1N4002
- D3, D4 = LED (3 mm φ)
- D5, D6 = DUS (24-hour version only)
- B = bridge rectifier BY164
- DP1... DP4 = HP5082-7760 or FND500
- IC1 = 3817D

Sundries:

- Tr = transformer, 12 V/300 mA secondary
- Re = relay, 12 V, >600Ω
- S1... S4 = single-pole pushbutton
- S5 = selector switch, 5-way
- S6 = change-over switch
- S7 = single-pole switch

the two modes will be discussed later. As the circuit diagram shows, all displays are driven individually — the segment drive outputs are not multiplexed. This will often prove to be an advantage. However, since the maximum drive current per segment output is only 8 mA, even this continuous operation will not produce a particularly bright display. High-efficiency LED displays are advisable, and the Hewlett Packard types proved to be the most suitable. The Fairchild displays are shown as an alternative, since the IC is sometimes supplied complete with these displays. The printed circuit board is designed to accommodate both alternatives.

The connections to the left-hand display (tens of hours) are rather unusual. For operation in the 12-hour mode, this display is connected as shown in figure 4. The 'b + c' output causes the two right-hand segments to light for 10, 11 and 12 o'clock. The upper left-hand segment ('f', see figure 3) lights to indicate 'AM', and the lower left-hand segment ('e') indicates 'PM'.

For operation in the 24-hour mode, the first display is connected as shown in figure 5. The '1Hz', 'AM', 'PM' and 'b + c' outputs now produce a '0', '1' or '2' as required.

2

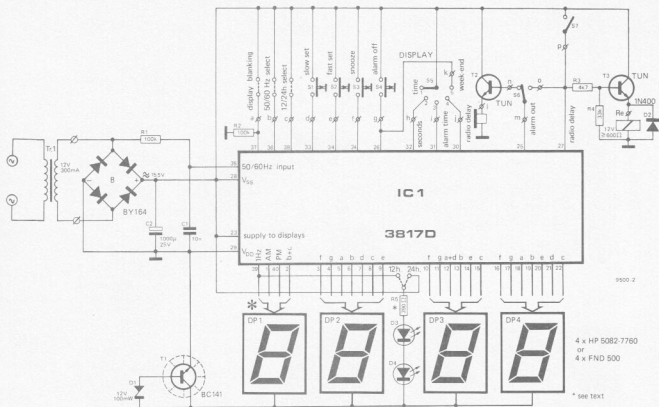

3

9500-3
common cathode

4

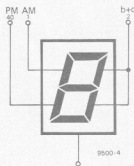

9500-4

5

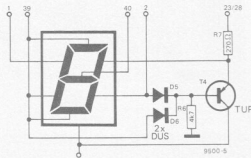

9500-5

Leds D3 and D4 are connected to the positive supply in the 24-hour mode. The value of R5 may have to be altered slightly to obtain the correct brightness. In the 12-hour mode it is also possible (not essential!) to connect these LEDs to the '1 Hz' output so that they flash on and off in a 1 Hz rhythm. The value of R5 should not be less than 270Ω in that case, however.

Operation

With switches S1...S4 all open and S5 in position 1, the clock is in the normal time-keeping mode. Switches S1 and S2 are for slow and fast setting of the clock. S5 is used for selecting the display

mode. As stated above, position 1 is the normal mode where the time is displayed in hours and minutes. In position 2, the units of minutes are displayed on DP2 and the seconds on DP3 and DP4.

Position 3 of S5 is used for setting the alarm. The alarm time is displayed in hours and minutes; it is set in the same way as the clock itself, using S1 and S2. The alarm can be reset to 12.00 hrs. (12-hour mode) or 00.00 hrs. (24-hours mode) by operating S1 and S2 simultaneously.

After setting the alarm, S5 is returned to position 1. When the alarm time is reached, a DC buzzer can be turned on via T2. Alternatively, with S6 in the

other position, T3 operates a relay which can be used to switch on a radio. The alarm can be turned off by pushing either S3 or S4. S4 turns it off completely; S3 is the 'snooze' position: if the alarm is silenced with this button, it will sound again after 10 minutes. In the week-end, for instance, the alarm can be put out of action entirely by setting S5 to position 5. This does not alter the setting of the alarm time.

The radio can be switched on by operating S7, for music-while-you-make-the-bed... It can also be used as an alternative to sleeping pills. For this, S5 is set to position 4 and S1 and S2 are used to set the number of minutes that the radio is to stay on. S5 can then be

Table 1.

display mode	S5 in position	function S1	function S2	S1 + S2 simultaneously
time (hours + minutes)	1	slow setting	fast setting	as S1
seconds (+ units of minutes)	2	stop	reset seconds to 00	reset clock to 12.00 (12-h.) or 00.00 (24-h.).
		(can be used as stopwatch)		
alarm time	3	slow setting of alarm time	fast setting of alarm time	reset alarm time to 12.00 (12-h.) or 00.00 (24-h.).
delay time before radio is switched off	4	delay, slow setting	delay, fast setting	as S2
time (hours + minutes); alarm out of action	5	as for position 1 of S5		

Figure 2. Complete circuit of the clock.

Figure 3. The seven segments of a display are indicated by the letters a . . . g.

Figure 4. Connections to DP1 for the 12-hour mode. Note that components D5, D6, R6, R7 and T4 are omitted in this mode.

Figure 5. Connections to DP1 for the 24-hour mode.

Figure 7. For mains-operated radios, the relay is mounted inside the set.

Figure 8. Connections to the relay for a battery-operated radio.

switched back to position I. The radio will now be turned off automatically after the allotted time; if it becomes desirable for some reason (a change of program, for instance) to switch it off sooner, S3 can be operated briefly.

Table 1 summarises the various possible operating modes.

Construction

A double-sided printed circuit board is used (figure 6). There are several differences between the 12-hour and the 24-hour version, but these are clearly marked on the component layout and in the parts list.

It is advisable to use a socket for the IC. In any case, it should be the last component that is mounted on the board.

The buzzer should be suitable for operation on 15 V DC, and it should not draw more than 100 mA.

T1 must be adequately cooled.

If the radio is mains operated, the relay should be mounted inside the radio as shown in figure 7. If it is battery operated, the relay can be mounted inside the clock as shown in figure 8. Obviously, the relay contacts should be suitable for the currents and voltages that it will have to switch.

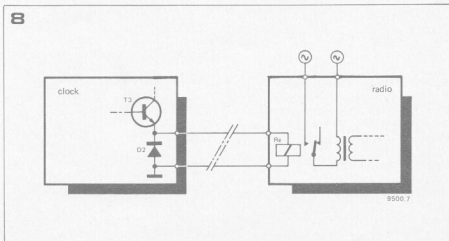
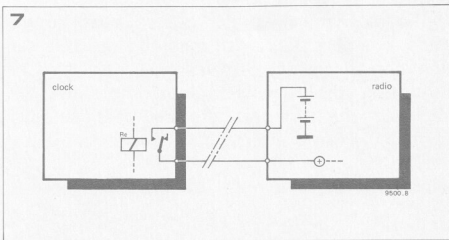

PARKING METER ALARM

J. Schmitz

In most large towns and cities (for that matter, in many small ones as well!), the parking meter is a very familiar sight. Installed in both likely and unlikely places in an attempt to alleviate the problem of insufficient parking spaces and at the same time, as profitable (?) sideline, to raise a little money which can then be spent on more 'no-parking' signs, the parking meter seems to be becoming a status symbol for progressive communities. If one is careful parking is still relatively cheap, but if one forgets to get back to the 'mechanical wonder' before it gets hungry again, one runs the risk of making a much larger donation to the city treasury.

By letting you know when your time is just about up, the little unit described here can pay for itself in one go.

The device is programmed by three switches which set the time interval between 15 and 105 minutes, and it will sound an alarm when the preset time has elapsed.

The alarm sounds for about 2 minutes and consists of a series of beeps and a flashing LED.

The circuit

To minimise power consumption, MOS ICs were used. Gate N2 and inverter N9 are used as the clock pulse generator circuit. This oscillator must be adjusted to an output frequency of about 2.5 Hz. This signal is then divided by a 14 stage binary counter (CD4020). The binary division outputs 2^{12} , 2^{13} and 2^{14} are available on pins 1, 2 and 3 respectively. These outputs are connected to NAND gate N1 via the three time program switches.

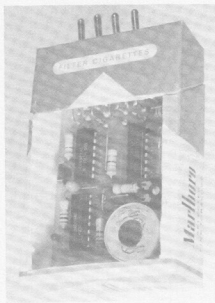

Parts list for figures 1 and 2.

Resistors:

R1, R4 = 1 M
R2 = 2M2
R3 = 220 k
R5 = 68 k
R6 = 100
P1 = 250 k preset

Capacitors:

C1 = 1 n
C2 = 470 n
C3 = 3n3

Semiconductors:

D1, D2 = DUS
D3 = LED
IC1 = CD4023
IC2 = CD4049
IC3 = CD4020

Sundries:

S1 ... S4 = miniature SPDT switches

Audio transducer = modified 1 k* earphone or a Sennheiser HM35 microphone capsule.

Battery = 3 x 1.2 V miniature mercury.

* See this month's 'missing link'.

When the unit is first switched on a short reset pulse is applied to the CD4020, resetting all the outputs to zero. If the switches are set as shown in the circuit diagram, pins 2 and 8 of gate N1 are held high and the third input to N1 is connected to the binary 2^{13} output.

When this output goes high the alarm will sound.

The time (T) required for this pin to go high depends on the clock frequency (f) as follows:

$$T = \frac{2^{12}}{2f} = \frac{4096}{2f}$$

For $f = 2.5$ Hz, the time is approximately 820 seconds, or 13 minutes 40 seconds.

The times for various switch settings are given in table 1.

Once this pin is high, and since the other two were already high, the output of gate N1 is low. Therefore the output

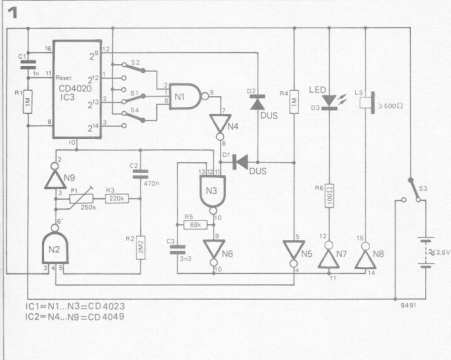

Figure 1. Circuit of the 'pocketronics' parking meter alarm. An audible and visual warning is given after a programmable preset interval.

Figure 2. Printed circuit board and component layout for the alarm. (EPS 9491).

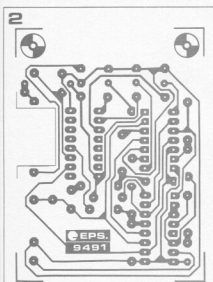

Table 1.

Switch settings	time to alarm	parking meter time	time left to return to meter
S2 S1 S4 (min : sec)	(min.)	(min.)	(min : sec)
- + +	13:40	15	1:20
+ - +	27:20	30	2:40
- - +	41:00	45	4:00
+ + -	54:40	60	5:20
- + -	68:20	75	6:40
+ - -	82:00	90	8:00
- - -	95:40	105	9:20

of N4 is high, and this enables gate N3. The other two inputs of N3 are the clock frequency and a tone source (gate N3 and inverter N6). Once gate N3 is enabled this tone is gated on and off by the clock frequency. This gated signal is fed to two inverter amplifiers, N7 and N8. They are used to drive a LED and a small audio transducer.

A discrete AND gate (D1, D2 and R4) is used to switch off the alarm after a short time. The parking meter timer can be reset by switching the main on-off switch (S3) to the off position and then back to on. When the unit is not in use it should be switched off.

To test and adjust the circuit, the three time program switches should first be put in the up position (connected to the battery). This should cause the alarm to sound and the LED to flash for just under 2 minutes.

P1 is used to adjust the clock pulse frequency, which should be set at 2.5 Hz. This frequency is important, and a small error in adjustment can cause large timing inaccuracies. If no frequency counter is available, the program switches should all be set in the 'up' position, so that the alarm sounds as soon as the unit is activated. The alarm should sound for 1 minute and 42 seconds. If not, P1 should be adjusted for that time. ■

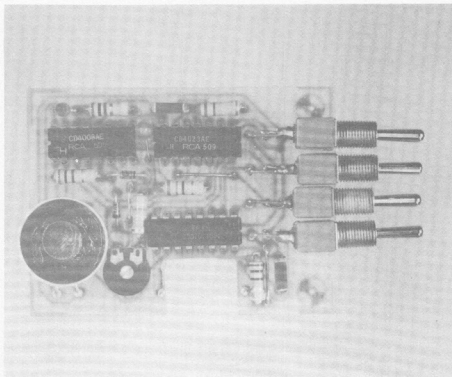

an invitation to investigate, improve on and implement imperfect but interesting ideas.

EJEKTOR

Class-B output stages without quiescent current (adjustment)

It is not so easy to dream up a circuit for a high-quality class-B output stage without quiescent current. As a compromise, one could consider a circuit where the quiescent current does not have to be accurately adjusted. However, this should not adversely affect the quality of the amplifier (crossover distortion). And this is where the difficulty lies.

In Elektor 8 (december 1975, p. 1220) the 'current dumping' principle proposed by Quad was discussed. This principle is illustrated schematically in figure 1.

Basically, there are two amplifiers A and B to drive the load. Amplifier A supplies a current $I(A)$ to fill the 'dead zone' where amplifier B refuses to do any work ($I(B) = 0$). If required, A can also be used to drive B, but that is not essential to the principle. If angle β of figure 1 can be reduced to (almost) zero, A will only have to supply current in the dead zone.

The transistors T1 and T2 in figure 2 form amplifier B. Amplifier A is the differential amplifier which amplifies the base-emitter voltage V_{be} by a factor one. The amplifiers are connected to the load R_L via the resistors R_B and R_A , respectively.

Let us assume now that a drive voltage V_i is applied between the bases of T1/T2 and junction P of figure 2*. As a function of V_i , the currents $I(A)$, $I(B)$, and I_L vary as follows (see figures 1 and 2):

The current supplied by amplifier B is:

$$I(B) = \frac{V_i - V_{be}}{R_B} \text{ for } |V_i| > |V_D|, \text{ and}$$

$$I(B) = 0 \text{ for } -V_D < V_i < V_D \text{ (for } V_D \text{ see figure 1).}$$

Since the output voltage of A equals V_D , its output current is:

$$I(A) = \frac{V_{be}}{R_A}$$

If $R_A = R_B = R$, the total current into the load becomes:

$$I_L = I(A) + I(B) = \frac{V_i}{R}. \text{ (Note that in the}$$

dead zone $I(B) = 0$, so $V_{be} = V_i!$).

This means that the output current, and thus the output voltage V_u , has become independent of V_{be} : the nasty characteristics of T1/T2 have no further effect. The principle on which the above set-up is based is known as 'adding what is lacking'. For further information see the list of literature.

* This is the condition if 'bootstrapping' is used. It is not an essential condition, however: it is also possible to refer the drive voltage to supply common.

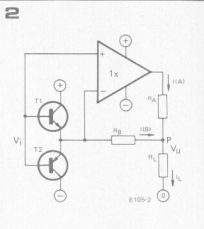

There is, however, a pitfall. Differential amplifier A of figure 2 must operate in Class-A for small signals. So quiescent current is needed after all!! (Remember the fundamental Law of Conservation of Misery . . .). However, it must be possible to arrive at a circuit which can do without quiescent current adjustment — in spite of spreads in diode and base-emitter voltages.

An alternative

The circuit of figure 3 is similar in some ways to the one already discussed. It is actually an extension of the circuit

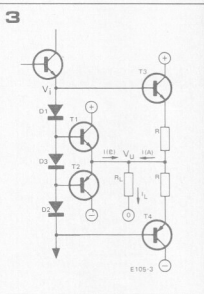

1

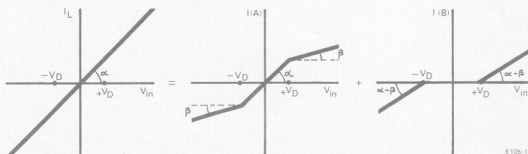

E105-1

principle used in the Edwin amplifier (Elektor 6, September 1975, p. 910).

The output stage comprising T1...T4 must be driven between input and ground, not between input and output, so it is connected as an emitter follower. In this circuit the fact that the I_L - V_i -characteristic of an emitter follower is highly dependent on the load resistance R_L is used to good advantage.

Transistors T1/T2 form amplifier B. The dead zone is halved by including D3. Transistors T3 and T4 are the 'adding' amplifier A. D1 and D2 cause a quiescent current to flow through T3 and T4. The sum of the voltage drops across the two resistors R equals the threshold voltage V_d of one diode.

For very low signal levels (V_i), only T3 and T4 supply current into the load. However, as soon as the input voltage exceeds $\pm \frac{1}{2}V_d$ T1 and T2 also start to conduct alternately. As the level of the input signal is increased further, T1 and T2 supply more and more current into the load. Under these conditions the current supplied by T3 and T4 does not increase, however: it is limited to approximately V_d/R .

This circuit differs from the first suggestion in that both amplifiers (A and B) now operate in Class-B.

Since the output stage works as an emitter follower, the slope of the characteristic in the dead zone equals

about $\frac{1}{(R_L + R)}$. Outside the dead zone, with T1 and T2 conducting, T3 and T4 can be considered as supplying a DC current into the load. The slope is then determined by amplifier B (T1 and T2), so it is about $\frac{1}{R_L + \frac{1}{S}}$, where S is the

slope (mutual conductance) of T1/T2.

Both R and $\frac{1}{S}$ can be made much smaller than R_L . This means that the slope of the overall characteristic is practically constant and depends only on R_L . Any remaining imperfections can be ironed out by using overall feedback.

Why not?

An entirely different approach to the problem can also be considered.

The magnetization curve of recording tape also has a dead zone. It has been found that h.f. 'bias' is one method of reducing the distortion caused by this. (In the early days of recording, DC bias was also tried - but it didn't work very well...)

This might also apply to output stages with a dead zone. Anybody who has heard the sounds coming out of oscillating power amplifiers with the quiescent current set to zero will know that they may sound awful - but there is no cross-over distortion! This approach has already been tried in a 'low-fi' application, with good results ('Loud-mouth', Elektor 18, October 1976, page 1048).

Literature

1. *Quad Complementary*, Elektor 8, December 1975, p. 1220.
2. *Equin (1)*, Elektor 12, April 1976, p. 448.
3. *The loud mouth*, Elektor 18, October 1976, p. 1048.
4. *Precision Electronics* (G. Klein and J.J. Zaalberg van Zelst), Chapter 27. (Philips Technical Library).

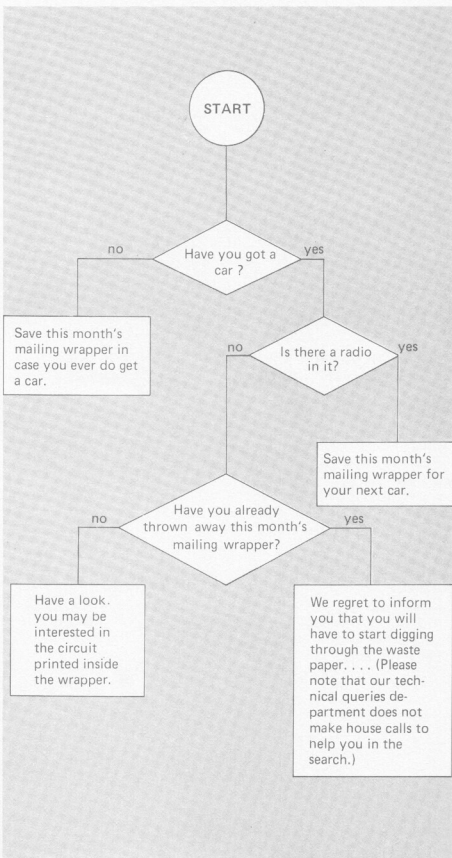

DRILL CONTROL



There are two basic types of speed control for electric drills. The most common type simply reduces the power to the drill to obtain a lower speed; this has the disadvantage that the speed of the drill depends on the load.

A more sophisticated type uses some form of feedback to hold the speed more or less constant at the required number of revs. The control described here is of the latter type. It is suitable for most electric drills, no matter what their power rating is, although some minor modifications will be required for really high-power drills.

be required (T_2). The operating point will therefore slide down the curve to point A_2 , corresponding to speed n_2 .

To keep the speed constant under most load conditions, some form of feedback is required.

In the ideal case, the result could be as shown in figure 2. Three curves are shown here, corresponding to three different values of motor current, but there are actually an infinite number of curves between zero and maximum current. Once again we can assume that A_1 is the off-load operating point. If the load increases, a higher torque is required (T_2). Instead of sliding down the I_1 curve, the operating point is now shifted to the I_2 curve to a point which corresponds to the higher torque at the same speed (A_2). In other words, the motor current is increased in such a way that the speed remains constant.

A normal electric drill works on alternating current. This means that some way must be found to alter the average value of an alternating current. The standard solution is to full-wave rectify it and pass it through a thyristor chopper.

For optimum results, the speed of a drill should be chosen to suit the type of material and the diameter of the drill. For ease of operation, it is desirable that the speed should remain more or less constant independent of the load. Both of these requirements can be fulfilled by using a sophisticated electronic speed control. This has the additional advantage that the drill will always run smoothly, even at low speeds.

The existing motor.

If a normal electric drill motor is driven with constant current, the torque varies with speed as shown in figure 1. This is approximately the situation when it is driven either directly from the mains or through a simple drill speed control unit. (Note, however, that the current does not stay constant in either of those cases: if the speed decreases, the current will increase. This reduces the effect of the load to some extent.)

Off-load, the drill will run, say, at speed n_1 and deliver torque T_1 ; this corresponds to point A_1 on the curve. If the load is now increased more torque will

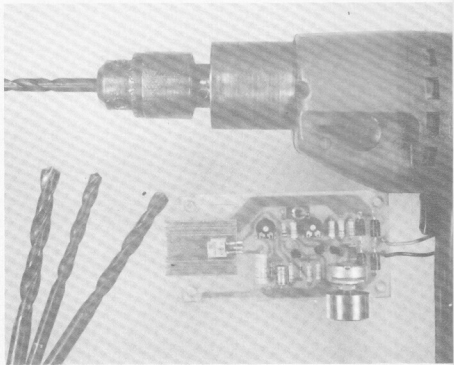

The thyristor is turned on at a specific point after every zero-crossing, as shown in figure 3. Since the 'specific point' corresponds to a certain phase angle, this is called 'phase angle control'. In the example shown, the average current increases from I_1 to I_3 as the phase angle decreases from 150° to 45° . It will be obvious that 180° corresponds to no current, whereas 0° would correspond to full drive.

Motor drive

The complete circuit of the motor control unit is shown in figure 4. It consists of a fairly standard thyristor control unit with an extra feedback loop. The basic control unit works as follows.

A full-wave rectifier (D1...D4) is connected in series with the motor. This has the advantage that a thyristor can be used for full-wave control. The alternative would have been to use a triac, of course, but this is more expensive in the long run.

The full-wave rectified AC voltage is passed through R1 to a bridge circuit. This consists of a capacitive branch R2/P1/C1 and a resistive branch R5/P2/R7. The capacitor introduces a phase lag in the first branch; the phase shift depends on the setting of P1.

The Darlington transistors T1 and T2 are connected between the two legs of the bridge. When C1 has charged to the point where the voltage on the emitter of T1 is 1.2 V higher than the voltage on its base, this transistor is turned on.

This causes both T1 and T2 to go into saturation, triggering the thyristor and discharging C1. This circuit has the advantages that the hysteresis is very small and that the phase angle can be varied over almost 180° .

The portion of the circuit described so far is quite a good drive unit in its own right. However, it is not a control unit

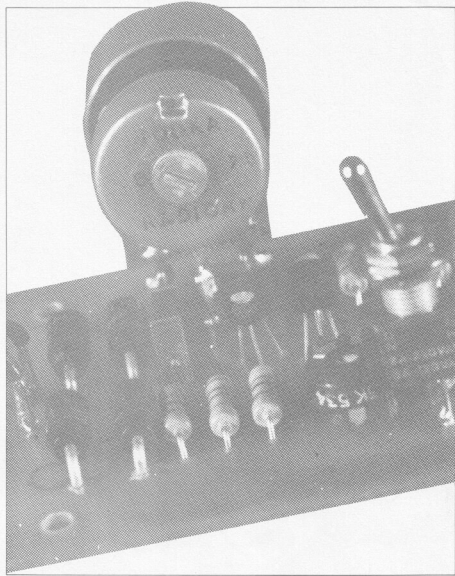

in the true sense: it does not maintain a constant speed independent of the load. To achieve this a feedback loop must be added.

Motor control

A current sensing resistor R8 is included in series with the thyristor. The voltage drop across this resistor is proportional to the current through the motor. This voltage is rectified by D5 and C2, and used to drive T3 through P3, R9 and D6.

The simplest way to understand the operation of this part of the circuit is to think of T3 as a voltage-controlled resistance.

As the load on the drill increases, its speed tends to drop. This causes the current through the motor to increase (the back EMF decreases with the speed), so the voltage across R8 increases. This, in turn, causes the base drive to T3 to increase so that the

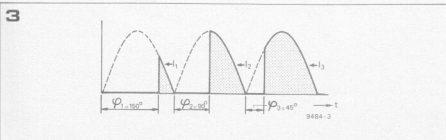
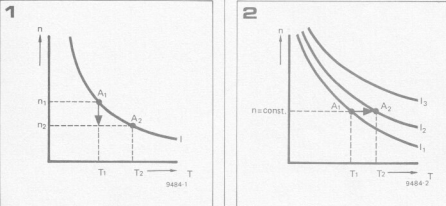

Figure 1. The relationship between motor speed and torque for constant-current drive.

Figure 2. An electronic motor control can keep the speed constant in spite of load variations.

Figure 3. The average current through the motor can be varied by altering the phase angle of the drive to the thyristor.

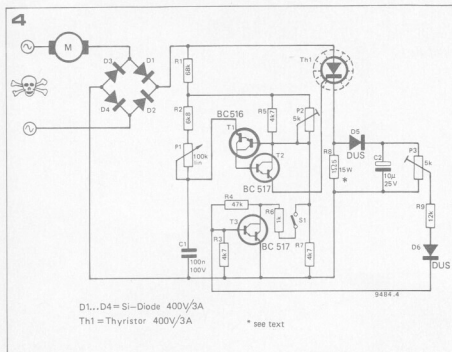
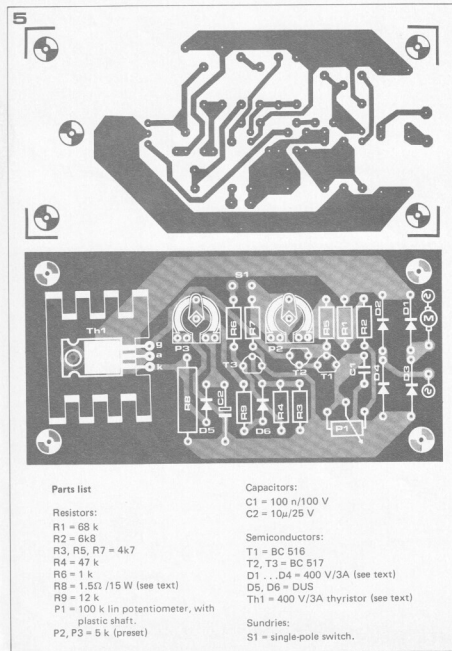

Figure 4. Complete circuit diagram.

Figure 5. Printed circuit board and component layout (EPS 9484).



'resistance' of T3 decreases. Provided S1 is closed, this decreases the voltage on the base of T1, causing the thyristor to be triggered sooner. The average current through the motor increases still further, offsetting the tendency for the speed to drop.

Note that this system really works with *positive feedback*! With the component values shown, and provided the alignment procedure is carried out correctly, this will not lead to oscillation. However, it can have a slightly disconcerting tendency to overcompensate: under some conditions, increasing the load will cause the motor to speed up!

The control loop can be put out of action by opening S1. The circuit will then operate like any normal speed control: the speed can be varied, but it will depend on the load to a much greater extent.

Alignment

Warning: The alignment procedure should be carried out with due care and using an insulated screwdriver! The entire circuit is connected to the mains. Alignment now proceeds as follows:

- Open switch S1: set P1 to the maximum resistance.
- Adjust P2 until the drill runs at the lowest speed that will be required. Check whether the motor starts without any problems when it is switched on; if not, readjust P2 slightly until it does.
- Turn the slider of P3 to the negative end of C2 and close S1.
- Turn up P3 slowly until the speed of the drill just starts to increase.

This completes the alignment procedure. P3 can now be used to set the speed of the drill as required.

The component values shown will be suitable for motors up to 400 W. For more powerful motors, diodes D1...D4 and the thyristor will have to be replaced by suitably up-rated types. Allow an adequate safety margin to cope with the heavy currents during switch-on. It will also be necessary to decrease the value of R8 accordingly.

Construction

As noted earlier, the entire unit is connected to the mains. Since it may well be used in damp surroundings, due care must be taken when building the unit and it *must* be built into a well-insulated box. For the same reasons, P1 *must* be a type with an insulated (plastic) shaft.

The mains connections should be good quality mains cable (three-core), with a rubber grommet and a cable clamp where it enters the box. A mains outlet can be mounted on the box for the connection to the drill.

Type	V _{CEO} (Volt)	I _c (max) (mA)	P _{max} (mW) not cooled: 0 = < 300 00 = 305-1000 cooled: 000 = 1-10 W 0000 = 10-35 W 00000 = > 40 W	h _{FE} (min)	case nr.	comments
PNP = P NPN = N	0 = < 20 00 = 25-40 000 = 45-60 0000 = 65-80 00000 = > 85	0 = < 50 00 = 55-100 000 = 105-400 0000 = 405-2 A		0 = < 20 00 = 25-50 000 = 55-120 0000 = > 125		
TUN N 0 00 0 0 000 0						
TUP P 0 00 0 0 000 0						
AC126 P 0 00 0 0 0000 2						
AF239 P 0 0 0 0 0 1						
BC127 N 000 00 0 0 000 2						
BC108 N 0 00 0 0 000 2						
BC109 N 0 00 0 0 0000 2						
BC140 N 00 0000 0000 0000 2						
BC141 N 000 0000 0000 00 2						
BC160 P 000 0000 0000 00 2						
BC161 P 000 0000 0000 00 2						
BC182 N 000 000 0 0 0000 2						
BC212 P 000 000 0 0 000 2						
BC546 N 0000 00 00 0000 2						
BC556 P 0000 00 00 000 2						
BD106 N 00 00000 00000 00 7						
BD130 N 000 00000 000000 0 7						
BD132 P 000 00000 000000 00 9						
BD137 N 000 000 0000 0000 9						
BD138 P 000 0000 0000 0000 9						
BD139 N 0000 0000 0000 0000 9						
BD140 P 0000 0000 0000 0000 9						
BDY20 N 0000 00000 000000 0 9						
BF180 N 0 0 0 0 000 1						
BF185 N 0 0 0 0 0 12						
BF194 N 0 0 0 0 000 10						
BF195 N 0 0 0 0 000 10						
BF199 N 00 0 0 0 000 11						
BF200 N 0 0 0 0 0 11						
BF254 N 00 0 0 0 000 11						
BF257 P 00000 00 00 00 2						
BF424 N 0 0 0 0 000 11						
BFX34 N 000 00000 00 00 2						
BFX89 N 0 0 0 0 0 1						
BFY90 N 0 0 0 0 0 1						
BSX19 N 0 0 0000 0 000 2						
BSX20 N 0 0 0000 0 000 2						
BSX61 N 000 0000 00 000 2						
HEP51 P 00 0000 00 000 1						
HEP53 N 00 0000 00 000 1						
HEP56 N 00 0000 00 000 5						
MJE171 P 000 00000 00000 00 9						
MJE180 N 00 00000 00000 00 9						
MJE181 N 000 00000 00000 00 9						
MJE140 N 00000 00000 000000 00 9						
MPS A05 N 000 0000 00 00 13						
MPS A06 N 0000 0000 00 00 13						
MPS A09 N 0000 00 00 000 13						
MPS A10 N 00 00 00 00 13						
MPS A13 N 00 00 00 000 13						
MPS A16 N 00 00 00 0000 13						
MPS A17 N 00 00 00 0000 13						
MPS A18 N 00 000 00 00 0000 13						
MPS A55 P 00 0000 00 00 13						
MPS A56 P 0000 0000 00 00 13						
MPS U01 N 00 00000 0000 00 14						
MPS U05 N 00 0000 0000 0000 14						
MPS U06 P 0000 00000 0000 00 14						
MPS208 N 0 00 00 00 13						
MPS3394 N 00 00 00 000 13						
MPS3702 P 00 00 00 00 13						
MPS3706 N 0 0000 00 00 13						
MPS5514 N 00 0000 00000 0000 13						
TIP29 P 00 0000 00000 0 3						
TIP31 P 00 00000 000000 0 3						
TIP32 P 00 00000 000000 0 3						
TIP340 N 000 0000 000000 0000 7						
TIP142 N 00000 00000 000000 0000 7						
TIP2955 P 000 00000 000000 0 3						
TIP3055 N 000 00000 000000 0 3						
TIP530 P 000 0000 000000 0000 3						
2N696 N 000 0000 0000 0 2						
2N706 N 0 0 0 0 0 2						
2N914 N 0 0000 0000 00 2						
2N1613 N 000 0000 00 00 2						
2N1711 N 000 0000 00 00 2						
2N1983 N 00 0000 00 000 2						
2N1984 N 00 0000 00 00 2						
2N2219 N 00 0000 00 00 2						
2N2222 N 00 0000 00 00 2						
2N2925 N 00 00 0 0 0000 13						
2N2955 P 00 00 0 0 0 2						
2N3054 N 00 00000 000000 00000 7						
2N3055 N 00 00000 000000 00000 7						
2N3053 N 00 0000 0000 0000 2						
2N3568 N 000 0000 0 000 13						
2N3638 P 00 0000 0 000 13						
2N3702 P 00 000 000 000 13						
2N3966 N 00 000 0000 000 2						
2N3904 N 00 000 0 00 13						
2N3905 P 00 000 000 000 13						
2N3906 P 00 000 000 000 13						
2N3907 N 000 0 0 000 13						
2N4123 N 00 000 000 000 13						
2N4124 N 00 000 0 000 13						
2N4126 P 00 000 0 000 13						
2N4401 N 00 0000 00 0 13						
2N4410 N 0000 0000 000 00 13						
2N4427 N 0 000 0000 00 2						
2N5183 N 0 0000 0000 00 2						

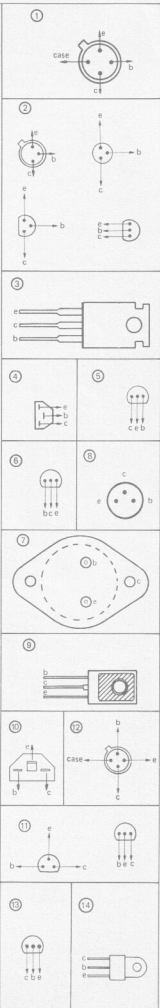

grounded base: f_T = 700 MHz

low noise

grounded base: f_T = 675 MHz
 grounded base: f_T = 220 MHz
 grounded emitter: f_T = 260 MHz
 grounded emitter: f_T = 200 MHz
 grounded emitter: f_T = 550 MHz
 grounded base: f_T = 240 MHz
 grounded emitter: f_T = 260 MHz
 grounded emitter: f_T = 90 MHz
 grounded emitter: f_T = 260 MHz
 grounded emitter: f_T = 70 MHz
 grounded emitter: f_T = 1000 MHz
 grounded emitter: f_T = 1000 MHz

f_T = 150 MHz
 f_T = 200 MHz
 f_T = 750 MHz

f_T = 300 MHz
 f_T = 100 MHz
 f_T = 480 MHz

Darlington
 Darlington

f_T = 500 MHz

f_T = 700 MHz

f_T = 700 MHz

CUMULATIVE INDEX FOR 1976

contents for Elektor Volume 2

Audio

a LOGICal replacement for the carbon-track pot	1147
class A amplifier re-considered	739
dynamic noise limiter	341
equin (1)	448
equin (2)	525
Hafler circuit for quasi-quadrophony	757
HI-Z stereo amplifier for headphones	716
infra-redphone	762
peak indicator	744
piano tuner	742
phasing and vibrato	1236
preco (1)	416
preco (2)	516
rain synthesizer	714
simple headphone amplifier	725
speech processor	225
SQL-200 (1)	938
SQL-200 (2)	1030
stereo indicator	763
super-bootstrap RC oscillator	764
symmetrical power amp	758
the LOUD mouth	1048
three channel mixer	735
triangular wave oscillator	728
variable slope filter	723
variable stereo width mixing stage	710
wien bridge oscillator	726
7 watt IC audio amplifier	755

Cars

ignition key reminder	734
ignition timing stroboscope	944
miles-per-gallon indicator	929
motorphone	711
parking meter alarm	1224
rev counter and dwell meter	921
rev counter for diesels	721
seat belt reminder	730
tachometer	916
voltage regulator for motorbikes	760
windscreen wiper delay circuits and how to install them	924

Displays

digits on TV	1034
homemade display	514
led fm scale	134
led light show	634
led meters	441
read-out brightness regulator	756
stereo led level meter	143
7 segment to BCD converter	1235

Domestic

albar	1110
a.m. mains intercom	618
bird-bell	757

capacitocoupling	1142
DEW line	1121
digibell	638
drill control	1228
high security burglar alarm sensor	149
intercom	1128
kettlestat	715
molestation	716
optical-lock	122
porch lighter	727
refrigerator alarm	1141
sensitive metal detector	1116
signal horn	1130
sixpence detector	123
tap doorbell	735
tapped code lock	726
thermometer	1212
touch activated dimmer	752
wireless bell extender	738

Games

a steady hand	714
battleships	131
lap counter	728
pin the tail on the donkey	139
poker	741
racing car control	128
score on screen for TV games (TV tennis)	1008
to drive or not to drive	119
TV tennis extensions (1)	318
TV tennis extensions (2)	453
TV tennis extensions (3)	544

Information articles

driving lessons	238
ejektor	625 and 1226
from stereo to SQ	934
image width control	523
missing link: link 75	624
music of the spheres	910
quadrille	910
servotape	928
supply decoupling	535
vertical fets	628
vhf fm reception	613

Music

digital master oscillator (1)	144
digital master oscillator (2)	241
hand-effect organ	760
ic rhythm generator	420
tremolo	745

Miscellaneous

AMV without R and C	736
aquastat	716
battery indicator	722
capacity relay	138

CUMULATIVE INDEX FOR 1976

contents for Elektor Volume 2

cricket	1133	morse typewriter	226
dark room aid	722	pll-ic stereo decoder	150
digital speed readout for turntables	748	preset aerial amplifier	765
driving LEDs from TTL	748	sample/hold synthesiser	747
electronic voting system	750	simple front-end for vhf fm	746
film slave	1135	simple mw receiver	140
frequency doubler using 4011	719	single sideband adapter	747
light sensitive astable multivibrator	710	super-plam	310
liquid level indicator	723	sqlchel	754
min-max temperature indicator	718	ssb adapter	731
MMV for ACG	744	ssb exciter with hf compressor	766
moisture indicator	764	ssb receiver	324
MOS monostable	732	trawler band converter	767
on-off TAP	742	tv modulator	739
one shot	745	tv sound — in brief	332
opto coupler with two LEDs	729	tv sound front-end adapter	334
quiz selector	761	wide band frequency doubler	722
schmitt trigger	741	200 MHz sample/hold adapter	760
sirens	1254		
solarstat	718	Test Equipment	
sound effects generator	754	acoustic logic probe	717
speech shifter	742	active oscilloscope probe	724
spike monoflop	733	audioscope	752
triac control	617	autoranger for dfm	1018
triac relay	331	channel quadrupler	610
VCO with 74123	734	digisplay	538
voltage-to-time converter	1131	fet front	620
wind machine	727	function generator ic 2206	124
		linear scale ohmmeter	758
		measuring pencil	612
Power Supplies		microammeter	731
battery charger	756	minivolt	1132
cascode current source	746	pip meter	750
current source	726	polarity indicator	715
dissipation dumper	754	pulse generator	1138
dual voltage regulators	1040	elektorscope (1)	1244
improved current source	1052	simple pulse generator	720
integrated voltage regulators (1)	348	sine-square-triangle generator	712
integrated voltage regulators (2)	436	single transistor sawtooth generator	739
power supply for varicap tuner	340	stylus balance	447
quad symmetrical supply	765	test logic	718
regulated + and — power supply	728	transistor tester	752
symmetrical regulated supply	763	versatile logic probe	553
TTL insurance	724	voltage to frequency converter	711
variable regulated supply	748		
0-30 V/1 A stabilised	739	Time Related	
		alarm	135
Radio		calendar	1124
aerial booster	723	car clock using watch ic	734
automatic call-sign generator	212	crystal timebase for synchronous clocks	721
aircraft communication receiver	736	digital wrist watch	231
alignment squeaker	1029	egg-timer-with-a-difference	1119
DSSC generator	756	handy dark room timer	750
feedback PLL for fm	110	perpetual solar clock	732
FM on 11 meters	1013	polaroid timer	434
integrated indoor fm aerial	510	reading-in-bed limiter	1145
masthead preamp	550	time on tv	1022
mini mw	130	snooze-alarm-radio-clock	1219
morse decoder	218		

TUP TUN DUG DUS

Wherever possible in Elektor circuits, transistors and diodes are simply marked 'TUP' (Transistor, Universal PNP), 'TUN' (Transistor, Universal NPN), 'DUG' (Diode, Universal Germanium) or 'DUS' (Diode, Universal Silicon). This indicates that a large group of similar devices can be used, provided they meet the minimum specifications listed in tables 1a and 1b.

For further information, see the article 'TUP-TUN-DUG-DUS' in Elektor 1, p. 9.

	type	U_{ce0} max	I_c max	h_{fe} min.	P_{tot} max	f_T min.
TUN	NPN	20 V	100 mA	100	100 mW	100 MHz
TUP	PNP	20 V	100 mA	100	100 mW	100 MHz

Table 1a. Minimum specifications for TUP and TUN.

Table 1b. Minimum specifications for DUS and DUG.

	type	U_R max	I_F max	I_R max	P_{tot} max	C_D max
DUS	Si	25 V	100 mA	1 μ A	250 mW	5 pF
DUG	Ge	20 V	35 mA	100 μ A	250 mW	10 pF

Table 2. Various transistor types that meet the TUN specifications.

TUN		
BC 107	BC 208	BC 384
BC 108	BC 209	BC 407
BC 109	BC 237	BC 408
BC 147	BC 238	BC 409
BC 148	BC 239	BC 413
BC 149	BC 317	BC 414
BC 171	BC 318	BC 547
BC 172	BC 319	BC 548
BC 173	BC 347	BC 549
BC 182	BC 348	BC 582
BC 183	BC 349	BC 583
BC 184	BC 382	BC 584
BC 207	BC 383	

Table 3. Various transistor types that meet the TUP specifications.

TUP		
BC 157	BC 253	BC 352
BC 158	BC 261	BC 415
BC 177	BC 262	BC 416
BC 178	BC 263	BC 417
BC 204	BC 307	BC 418
BC 205	BC 308	BC 419
BC 206	BC 309	BC 512
BC 212	BC 320	BC 513
BC 213	BC 321	BC 514
BC 214	BC 322	BC 557
BC 251	BC 350	BC 558
BC 252	BC 351	BC 559

Table 4. Various diodes that meet the DUS or DUG specifications.

DUS		DUG
BA 127	BA 318	OA 85
BA 217	BAX13	OA 91
BA 218	BAY61	OA 95
BA 221	1N914	AA 116
BA 222	1N4148	
BA 317		

Table 5. Minimum specifications for the BC107, -108, -109 and BC177, -178, -179 families (according to the Pro-Electron standard). Note that the BC179 does not necessarily meet the TUP specification ($I_{c,max} = 50$ mA).

	NPN	PNP
	BC 107 BC 108 BC 109	BC 177 BC 178 BC 179
V_{ce0} max	45 V 20 V 20 V	45 V 25 V 20 V
V_{eb0} max	6 V 5 V 5 V	5 V 5 V 5 V
I_c max	100 mA 100 mA 100 mA	100 mA 100 mA 50 mA
P_{tot} max	300 mW 300 mW 300 mW	300 mW 300 mW 300 mW
f_T min.	150 MHz 150 MHz 150 MHz	130 MHz 130 MHz 130 MHz
F max	10 dB 10 dB 4 dB	10 dB 10 dB 4 dB

The letters after the type number denote the current gain:

- A: α' (β , h_{fe}) = 125-260
 B: α' (β , h_{fe}) = 240-500
 C: α' (β , h_{fe}) = 450-900.

Table 6. Various equivalents for the BC107, -108, ... families. The data are those given by the Pro-Electron standard; individual manufacturers will sometimes give better specifications for their own products.

NPN	PNP	Case	Remarks
BC 107	BC 177		
BC 108	BC 178		
BC 109	BC 179		
BC 147	BC 157		$P_{max} = 250$ mW
BC 148	BC 158		
BC 149	BC 159		
BC 207	BC 204		
BC 208	BC 205		
BC 209	BC 206		
BC 237	BC 307		
BC 238	BC 308		
BC 239	BC 309		
BC 317	BC 320		$I_{c,max} = 150$ mA
BC 318	BC 321		
BC 319	BC 322		
BC 347	BC 350		
BC 348	BC 351		
BC 349	BC 352		
BC 407	BC 417		$P_{max} = 250$ mW
BC 408	BC 418		
BC 409	BC 419		
BC 547	BC 557		$P_{max} = 500$ mW
BC 548	BC 558		
BC 549	BC 559		
BC 167	BC 257		169/259
BC 168	BC 258		$I_{c,max} = 50$ mA
BC 169	BC 259		
BC 171	BC 251		251 ... 253
BC 172	BC 252		low noise
BC 173	BC 253		
BC 182	BC 212		$I_{c,max} = 200$ mA
BC 183	BC 213		
BC 184	BC 214		
BC 582	BC 512		$I_{c,max} = 200$ mA
BC 583	BC 513		
BC 584	BC 514		
BC 414	BC 416		low noise
BC 414	BC 416		
BC 414	BC 416		
BC 413	BC 415		low noise
BC 413	BC 415		
BC 382			
BC 383			
BC 384			
BC 437			$P_{max} = 220$ mW
BC 438			
BC 439			
BC 467			$P_{max} = 220$ mW
BC 468			
BC 469			
	BC 261		low noise
	BC 262		
	BC 263		

TUP TUN DUG DUS

SEVEN-SEGMENT TO BCD CONVERTER

MSI and LSI chips as used in clocks, pocket calculators and the like are now being offered at surprisingly low prices. However, if they are intended for driving a display the readout information is often presented in multiplexed seven-segment format.

This is all right for the display, but it is not much use for anything else.

If a 'normal' digital output is added, the field of application can be extended to include the use of a printer as well as other devices. What is required is a unit that will convert the seven-segment code into a binary coded decimal format (BCD). The BCD output will still be multiplexed, but this is easily remedied by adding a series to parallel converter (a shift register).

The circuit shown in figure 1 performs the seven-segment to BCD code conversion. This particular circuit requires positive logic inputs, that is to say, an energised segment must correspond to logic '1'.

Figure 2 shows the circuit for negative

Table 1

Decimal to seven-segment to BCD encoding

Decimal	Seven-segment							BCD			
	a	b	c	d	e	f	g	D	C	B	A
0	1	1	1	1	1	1	0	0	0	0	0
1	0	1	1	0	0	0	0	0	0	0	1
2	1	1	0	1	1	0	1	0	0	1	0
3	1	1	1	0	0	1	0	0	0	1	0
4	0	1	1	0	0	1	1	0	1	0	1
5	1	0	1	1	0	1	1	0	1	0	1
6	1	0	1	1	1	1	1	0	1	1	0
7	1	1	1	0	0	0	0	0	1	1	1
8	1	1	1	1	1	1	1	1	0	0	0
9	1	1	1	1	0	1	1	1	0	0	1

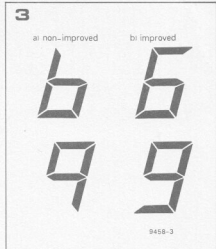
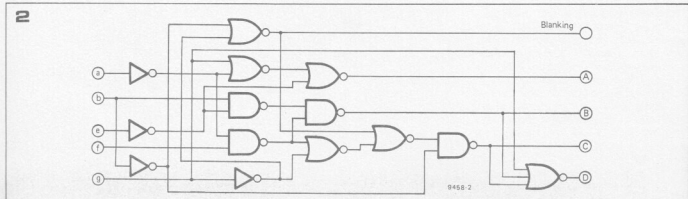
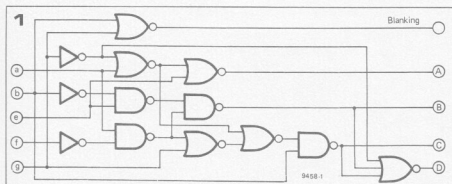

logic, where an energised segment corresponds to logic 'zero'. Only 5 out of the 7 available segment outputs are used, as shown in the diagram, since these are sufficient to produce the conversion to BCD code.

Table 1 shows the relationship between the 'improved' (figure 3b) seven-segment code and the BCD code. The circles around the '1' in columns 'a' and 'd' for decimals 6 and 9 respectively, indicate that a '1' will appear in these places in the non-improved code (figure 3a). The converter will supply the same BCD code at the output in both cases.

With the segments de-energised, as when all the inputs are 'zero' in figure 1 the blanking output will also be 'zero'. This can be utilised to block the information at the BCD output if required. In some cases it can also be used for clocking a shift register which is used to unscramble the multiplexed output from an IC.

Figure 1. Code converter circuit for positive input logic. Information given by segments e and d is redundant and therefore not included.

Figure 2. Code converter circuit for negative input logic.

Figure 3. The improved code is sometimes used to give better readability to these digits.

PHASING AND VIBRATO WITH ANALOGUE SHIFT REGISTER

In the article entitled 'Phasing' (Elektor No. 6) mention was made of the analogue shift register type TCA 590. Unfortunately, this particular IC was never generally released, but an improved version, the TDA 1022, is now available. In this article some applications of the TDA 1022 are described, including a phasing and vibrato unit.

Many interesting effects may be produced by delaying an audio signal, depending on the delay time and how the delayed and direct signals are processed. For example, if a delayed signal is mixed with the direct signal then, at frequencies where the delay is an odd number of half periods of the signal waveform the two signals will be 180° out of phase and will cancel. If a signal is passed through a delay unit whose delay can be continuously varied in a cyclic manner then the signal can be frequency modulated giving a vibrato effect. Longer delays can be used to give echo and reverberation effects, though these are not discussed in detail in this article.

Delay Lines

Until recently the only delay units available to the amateur were of the spring line type. In this type of delay unit an acoustic signal is fed into one end of a helical spring by a transducer. The signal travels round the coils of the spring until it reaches the other end where a second transducer reconverts it to an electrical signal. This type of delay line has many limitations. It is extremely microphonic and so must be mounted on an isolating suspension system. If the transducers are not properly matched to the spring there may be reflections up and down the line, and finally the spring exhibits resonance modes of its own, so that the frequency response is far from flat. The trend now is toward completely

electronic forms of delay. What these all have in common is that the signal is not transmitted through the delay unit continuously, but is sampled (at a frequency at least twice the highest signal frequency). The sampled signal is then clocked through a shift register and arrives at the output after n clock pulses, where n is the number of bits in the shift register. The reconstituted signal

is then passed through a low-pass filter to remove the clock frequency component.

The shift register may be digital or analogue. Since a digital shift register can only deal with logic '0' or '1' levels it must be preceded by an A/D converter to convert the sampled signal voltage to a corresponding digital code.

At the output the digital code is changed back into an analogue signal by a D/A converter. Systems using analogue shift registers are much simpler, since such shift registers can accept analogue signals direct. However, the circuit simplicity is to some extent offset by the greater cost of the analogue shift register IC's.

Analogue shift registers are commonly referred to as 'bucket-brigade' memories, the reason being that their operation is analogous to a chain of men passing buckets of water from hand to hand when fire-fighting. In the case of the analogue shift register the 'buckets' are capacitors and the 'water' is packets of electric charge corresponding to each sample of the signal waveform. Of course the capacitors do not move, but charge is transferred from one capacitor to another.

The bucket analogy is developed further in figures 1a and 1b, which show just four of the buckets in a chain. In figure 1a at time t the odd-numbered buckets (capacitors) carry amounts of water (charge) corresponding to the samples taken of the signal waveform. The even-numbered buckets are empty. Each odd-numbered bucket is then emptied into the next even-numbered bucket, so that by time $t + \frac{1}{2}$ the water has been transferred to the even-numbered buckets. The final step is to pour the water from the even-numbered buckets into the next odd-numbered bucket, so that by time $t + 1$ the water will have been transferred to the right by two

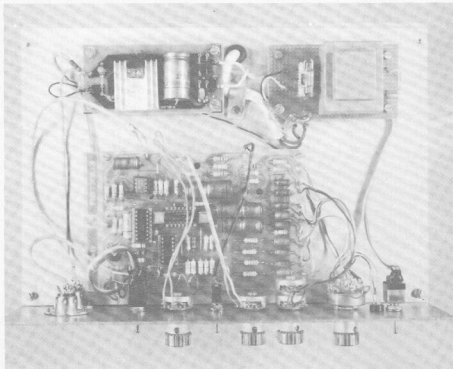

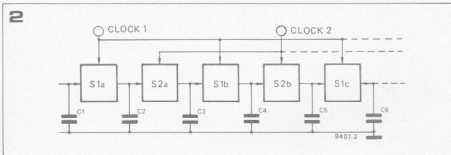
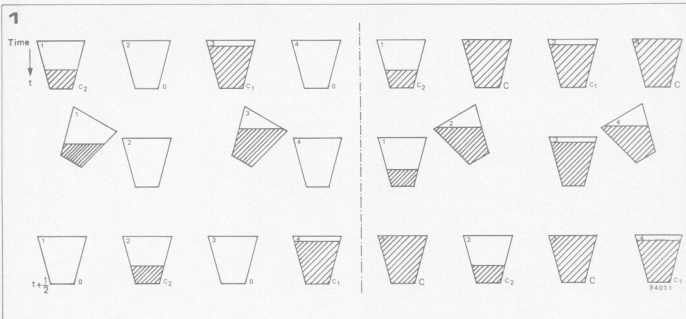

buckets. Figure 1b shows a different method of obtaining the same result. In this case the even-numbered buckets start off full of water. The odd-numbered buckets are then filled from the even-numbered buckets, so that at time $t + \frac{1}{2}$ the odd-numbered buckets are full while the even-numbered buckets contain the amount of water originally in the odd-numbered buckets.

Figure 1. Principle of the 'bucket-brigade' shift register.

Figure 2. Basic arrangement of the analogue shift register showing two-phase clock connections.



The even-numbered buckets are then filled from the odd buckets, so that at time $t + 1$ the even buckets are again full, but the amounts of water in the odd buckets have been shifted two places to the right.

In the analogue shift register IC the 'buckets' are, of course, capacitors and charge is transferred from one capacitor to another through FET switches controlled by a two-phase clock, that is to say the clock pulse generator has two outputs, and when one output is high the other is low. In figure 2 C1 is charged to a voltage equal to the instantaneous value of the input signal. If the other capacitors are all initially charged to a higher voltage then when clock 1 is high and S1a, b, c, . . . are open current will flow from C2 into C1, and the voltage on C2 will fall. Then when clock 2 goes high current will flow from C3 into C2.

When clock 1 again goes high current will flow from C4 into C3, and so on. In this way the input signal will be transferred through the shift register. This is of course a gross simplification of the operation of the IC, since if S1a, b, c, . . . and S2a, b, c, . . . were nothing more than clock-driven switches C3 would not discharge to the initial voltage on C2: both capacitors would assume a voltage midway between the initial voltage on C2 and that on C3. The actual operation of the IC is considerably more complex, to ensure that the voltage presented at the input is faithfully transferred through the capacitor chain without distortion or attenuation.

The basic internal circuit of the TDA 1022 is given in figure 4. The IC contains a total of 514 FET switches and their associated capacitors. The input signal is fed to pin 5. When clock 1 (pin 1) is high the first FET will be switched on and the first capacitor will charge to the instantaneous value of the input signal. When clock 2 goes high T1 will turn on and the second capacitor will discharge through T1

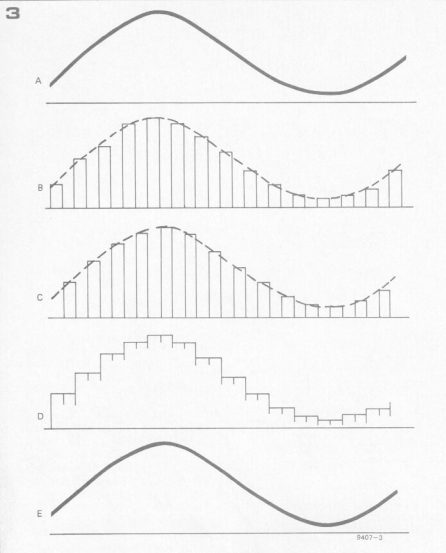

into the first capacitor until the voltage on the first capacitor (and on the source terminal of T1) has risen sufficiently to cause T1 to cut off. The voltage across the second capacitor is now equal to the initial voltage on the first capacitor. When clock 1 again goes high the third capacitor will discharge into the second capacitor through T2 and the unmarked FET (these are included to improve the blocking characteristics of the switches) and so on. The IC is provided with two outputs, one from the even-numbered FET no. 512 and one from the odd-numbered FET no. 513.

The output waveform from FET 513 is the same as that from 512, but delayed by half a clock pulse. Since the input waveform (figure 3a) is sampled only during the odd numbered clock pulses then if only one of the outputs were used the output waveform would consist of a sequence of samples with gaps between them (figures 3b and 3c). This would contain a very large component at the clock frequency, which would be difficult to eliminate. However, by mixing outputs 512 and 513 (figures 3b and 3c) the gaps can be 'filled in' giving a waveform as in figure 3d. The small switching spikes can easily be removed by a low pass filter so that the original waveform is recovered (figure 3e).

Practical Applications

The sampled signal passing through the TDA 1022 is shifted two places per clock pulse period (one place during the odd clock pulse and one place during the even clock pulse). It will

4

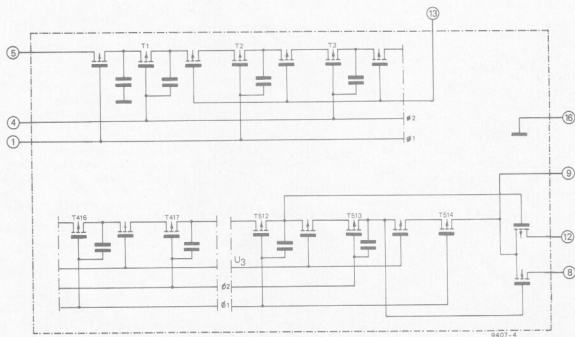

thus require a delay of 256 clock pulses for a signal to pass from the input to output 512. The manufacturer's data states that clock frequencies between 5 kHz and 500 kHz may be used, so that the time delay introduced by the IC may be varied between 51.2 ms and 512 μ s. To obtain longer delays several IC's may be cascaded.

The lowest clock frequency that may be used in any particular application is dependent on the highest signal frequency. The clock must be at least twice the highest signal frequency. In practice, so that the clock frequency may easily be filtered out without attenuating the high-frequency components of the signal, even higher clock frequencies may be used, but this of course reduces the delay time.

Block diagrams of three basic applications of the TDA 1022 are given in figures 5-7. The simplest application is as an audio delay line (figure 5), and in this application all that is required is the TDA 1022 and a two-phase clock generator. Vibrato effects may be obtained by making the clock generator a voltage controlled oscillator and modulating it with a low frequency signal (figure 6). In this way the sampled signal is alternately 'speeded up' and 'slowed down' in its passage through the shift register thus introducing phase modulation. This has considerable advantages when used in electronic organs over the usual method of producing vibrato (i.e. modulation of the master oscillators). Since frequency modulation of the master oscillators is no longer required they can be made much more stable. Also,

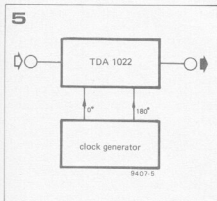

Figure 3. Showing sampling of an analogue signal and mixing of odd and even outputs to minimise clock frequency component.

Figure 4. Basic internal circuit of the TDA 1022.

Figure 5. The TDA 1022 connected as an audio delay line.

Figure 6. Vibrato using the TDA 1022.

Figure 7. The TDA 1022 as a phasing unit.

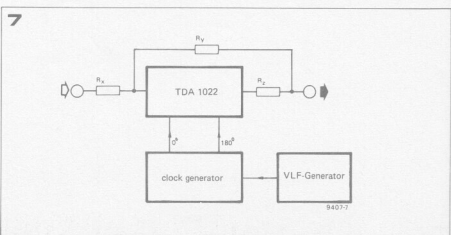
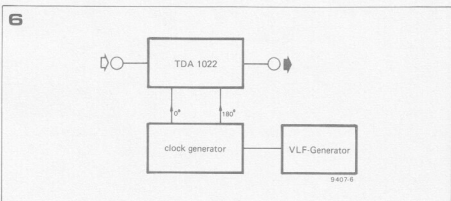

8

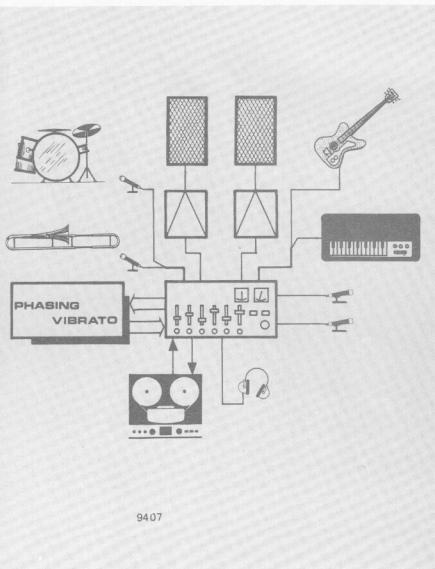
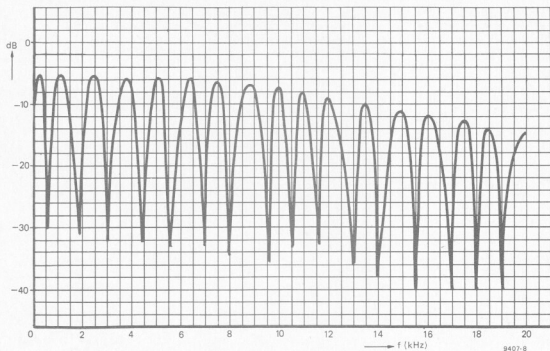

9407

vibrato may be applied to only one manual of the organ if required, and not necessarily to all manuals and pedals, as is the case with the older method. Vibrato may also be applied to any other instrument or combination of instruments — even to recordings of a full orchestra — with interesting results. The third effect obtainable with the TDA 1022 is phasing (figure 7). Here the direct and delayed signals are summed, resistors R_Y and R_Z being chosen so that both signals have the same amplitude. At frequencies where the delay is equal to an odd number of half-periods of the signal frequency the direct and delayed signals will be 180° out of phase and will cancel each other out. For example, if the delay is set to 5 ms and the input frequency is 100 Hz cancellation will occur since the half-period of a 100 Hz signal is 5 ms and the delayed signal will thus arrive 180° out of phase with the direct signal. This would also be true at frequencies of 300, 500, 700 Hz etc. Conversely, at frequencies where the delay is an even number of half-periods the delayed and

Figure 8. 'Comb filter' response of the phasing unit.

Figure 9. Complete circuit of a phasing and vibrato unit using the TDA 1022.

direct signals will be in phase and will reinforce, in the example given this would occur at frequencies of 200, 400, 600 Hz etc. This type of response produces a series of attenuation notches throughout the spectrum at the odd harmonics of the fundamental frequency (i.e. the frequency at which the delay equals one half-period) and in consequence is known as a comb-filter response. An example is given in figure 8.

The phasing effect may be further enhanced by frequency-modulating the clock generator with a low-frequency signal, thus varying the delay and sweeping the comb response up and down the spectrum.

A complete practical circuit for a phasing and vibrato unit is given in figure 9. The low-frequency vibrato oscillator is a phase-shift oscillator comprising T4, T5 and the associated frequency determining components. Three frequency ranges may be selected by S3, i.e. approx. 0.3 to 1.3 Hz, 0.9 to 2.8 Hz and 2 to 6.5 Hz, but due to the capacitor tolerances the actual ranges may vary considerably from this. However this is not a great disadvantage as the frequency in each range may be continuously varied by P4.

The output of the vibrato oscillator is

taken from the emitter of T5, amplified by T6 and used to frequency modulate an XR2207 voltage controlled oscillator (VCO). The amplitude of the vibrato signal, and hence the frequency deviation of the VCO may be adjusted by P3. The free-running or centre frequency of the VCO is set by P2. An external vibrato signal may be fed in at points 'ext 1' or 'ext 2' by switching S2 or S4 to the appropriate position. The sensitivity of the ext 1 input is of the order of a few volts, whereas the ext 2 input, feeding into T6, has a sensitivity of a few hundred millivolts. With no external input S2 may be used to switch out the internal vibrato oscillator. In this case R40 keeps C10 charged to the same potential as the collector of T6 so that when the internal vibrato is switched back in there is no switch-on transient. However, leakage of the internal vibrato signal through this resistor may be a problem, in which case it may be increased or omitted.

The XR2207 has only a single-phase output, so this output is fed to a TTL flip-flop which divides the output frequency by two and also provides two-phase outputs from its Q and Q pins. The 5 V supply required by this IC is provided by a simple stabilizer built

around zener diode D1 and T3.

The outputs of IC3 drive a buffer stage comprising T1 and T2, which is rather special for several reasons. Firstly, since each 'bucket' capacitor in the IC is about 1 pF the two-phase clock must be able to drive a large capacitive load, since it sees all these capacitors connected in parallel. Secondly, the risetime of the clock pulse edges must be very short to minimise switching spikes and avoid damage to the IC that might result if the two clock phases overlapped. For these reasons the buffer stage has a low output impedance, and positive feedback is provided between the transistors (via R16 and R17) to achieve fast switching.

The operation of the TDA 1022 has already been discussed and the only point of interest in this part of the circuit is P1, which is an offset control to set the DC bias conditions at the IC input. S1 provides switching for either phasing or vibrato modes. In the phasing mode the direct signal is summed with the delayed signal via R2, whereas in the vibrato mode only the delayed signal is used. Resistor R41 and capacitor C26 may be required if switching clicks are audible. Note that they must be mounted 'out-board', as shown in figure 12.

9

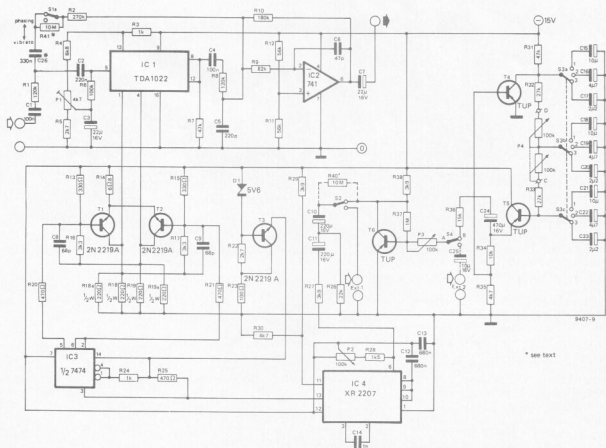

* see text

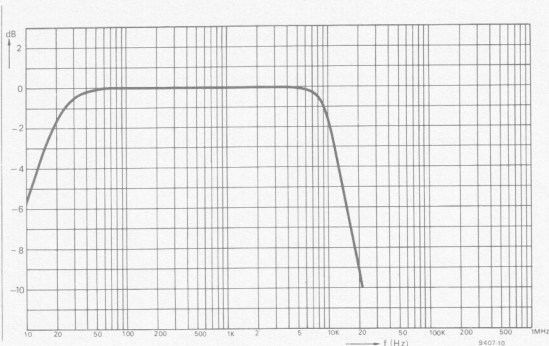

Filtering to remove the residual clock frequency components is accomplished by an active low-pass filter built around IC2. The frequency response of this filter is shown in figure 10.

Construction

A printed circuit board and component layout for the phasing and vibrato unit are given in figure 11, and the construction should present few difficulties. This p.c.b. is, of course, for only a single channel, but if more than one channel is required the only parts of the circuit that must be duplicated are the clock buffer stage, the TDA1022 and the low-pass filter. The vibrato oscillator and clock generator will serve for both channels, unless complete independence is required.

Operation

For operation as an audio delay line S2 is placed in position ext. 1 and S1 in the vibrato position. The delay time is then varied simply by altering the clock frequency with P2.

For a vibrato effect the internal vibrato oscillator may be switched in by S2, or an external oscillator may be fed into one of the input sockets. The vibrato frequency may be selected by S3 and adjusted by P4. A fast vibrato (S3 in position 3) usually sounds best, as a slow vibrato simply sounds like wow from an eccentric record. For the best effect the modulation depth (clock frequency deviation) should be kept low and a clock frequency of about 100 kHz should be used. Over-modulation of the clock generator may cause it to cut out altogether. For phasing, on the other hand, (S1

Parts list

Resistors:

R1, R8 = 120 k
 R2 = 270 k
 R3, R24 = 1 k
 R4 = 6k8
 R5, R22 = 2k7
 R6 = 100 k
 R7, R31 = 47 k
 R9 = 82 k
 R10 = 180 k
 R11, R12 = 56 k
 R13, R15 = 330 Ω
 R14 = 60Ω
 R16, R17 = 3k3
 R18, R19 = 220 Ω, ½ W
 R20, R21, R25 = 470 Ω
 R23 = 100 Ω
 R26 = 22 k
 R27, R29, R38 = 3k9
 R28 = 1k5
 R30, R35 = 4k7
 R32, R33 = 27 k
 R34 = 10 k
 R36 = 15 k
 R37 = 1 M
 R39 = omitted
 R40, R41 = 10 M*
 P1 = 4k7, preset
 P2, P3 = 100 k, lin.
 P4 = 2 x 100 k, lin.

Capacitors:

C1, C4 = 100 n
 C2 = 220 n
 C3, C7 = 22 μ/16 V
 C5 = 220 p
 C6 = 47 p
 C8, C9 = 68 p
 C10, C11 = 220 μ/16 V
 C12, C13 = 680 n
 C14 = 1 n
 C15, C18, C21, C25 = 10 μ/16 V
 C16, C19, C22 = 4μ7/16 V
 C17, C20, C23 = 2μ2/16 V
 C24 = 470 μ/16 V
 C26 = 330 n*

Semiconductors:

IC1 = TDA 1022
 IC2 = 741
 IC3 = 7474
 IC4 = XR 2207
 T1, T2, T3 = 2N2219, BC140
 T4, T5, T6 = TUP
 D1 = zener 5V6, 250 mW

Switches:

S1, S2, S4 = single pole (SPST)
 S3 = 3-pole 3-way

* see text

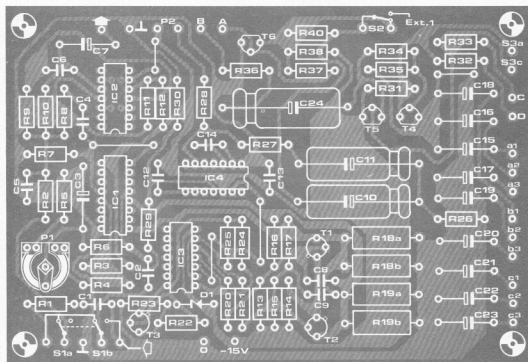
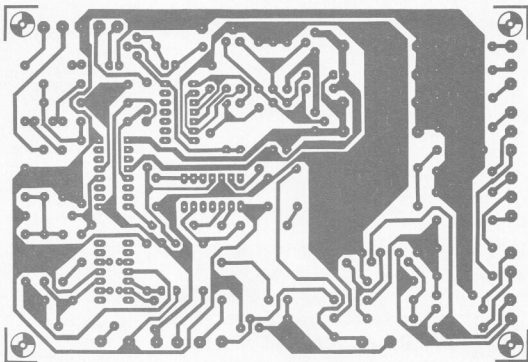
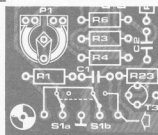

Figure 10. Frequency response of the output filter.

Figure 11. Printed circuit board and component layout for the phasing and vibrato unit.

Figure 12. Note that the original component layout shows an older input switching arrangement. S1 and the additional components R41 and C26 are mounted off the board, as shown here.



is phasing position). The clock frequency should be about 300 kHz and a greater modulation depth should be used at a lower frequency.

Other possibilities

Another interesting possibility using the TDA 1022 is reverberation. Unfortunately, the delay obtainable with a single TDA 1022 at a reasonable signal bandwidth is insufficient for this purpose, so several must be cascaded. As these IC's are somewhat pricey this becomes an expensive proposition, but may be possible in the future if prices become more reasonable.

ELEKTROSCOPE

(1)

The Elektroscope is a dual-trace general purpose oscilloscope for the home constructor. In this design the accent has been placed on reliability, ease of construction and simplicity of operation, rather than on elaborate facilities that will rarely be used and extremely high performance circuits that the home constructor has not the equipment to calibrate. To simplify wiring, the oscilloscope is of modular construction, with Y amplifiers and timebase that plug into a motherboard containing most of the interwiring.

This series of articles will proceed in the most logical order for the assembly of the oscilloscope, though it is recommended that construction is not commenced until the series is complete. The reader will then have a better idea of the complexity of the project, and will be able to order all the components at once, thus taking advantage of quantity discounts.

Having first described the general layout of the Elektroscope, the remainder of this article will deal with the power supplies, since none of the other circuits may be tested until the power supplies are built. Choice of cathode ray tube (CRT) and tube bias circuits will also be discussed. The second article will deal with timebase and trigger circuits, and with the horizontal and vertical deflection amplifiers. The final article will deal with the channel switching circuits and with general constructional and calibration details.

General Layout

The Elektroscope is a dual trace oscilloscope. A single beam CRT is used, so the dual trace facility is achieved by the usual method of switching the beam between the Y1 and Y2 inputs. At low timebase speeds the input to the Y output stage is switched between the outputs of the two Y preamplifiers at high frequency so that the appearance is of two independent traces on the screen (chopped mode). At high timebase speeds this is no longer practical as the

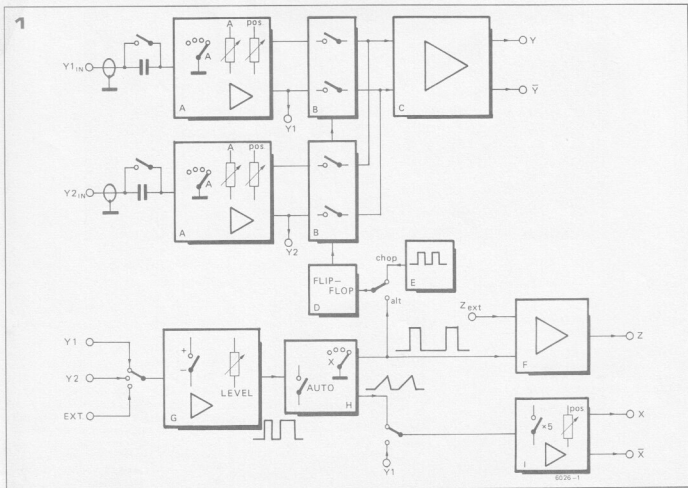

2

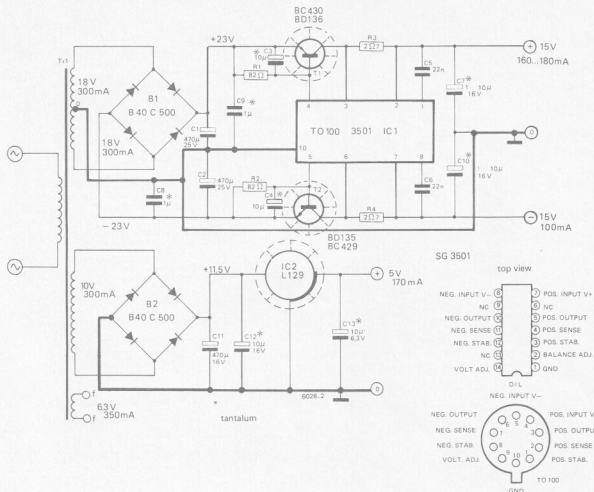

3

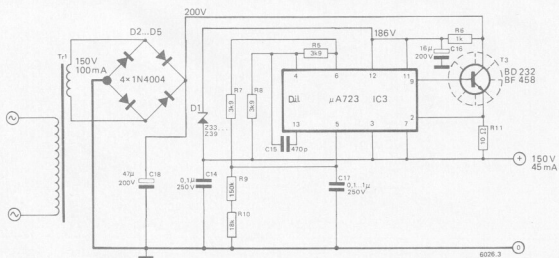

Figure 1. Block diagram of the Elektroskope.

Figures 2 and 3. Stabilized power supplies for the Elektroskope.

chopping frequency would have to be extremely high (much higher than the timebase repetition frequency). Accordingly, the Y output stage is switched between the Y preamps on alternate sweeps of the timebase, so that on one sweep the waveform at the Y1 input is traced, and on the next sweep the waveform at the Y2 input is traced (hence alternate mode). The chopped or alternate mode is selected automatically depending on the position of the timebase switch.

A block diagram of the Elektroskope is given in figure 1. Blocks 'A' are the two Y preamplifiers with input attenuators, fine sensitivity and position controls. Blocks 'B' are the electronic switches that select the output of either the Y1 or Y2 preamplifier, and block C is the Y output amplifier, which provides a high voltage drive to the Y plates of the CRT.

The electronic switches are controlled by a flip-flop, block 'D'. In the chopped mode this is clocked by a high-fre-

4

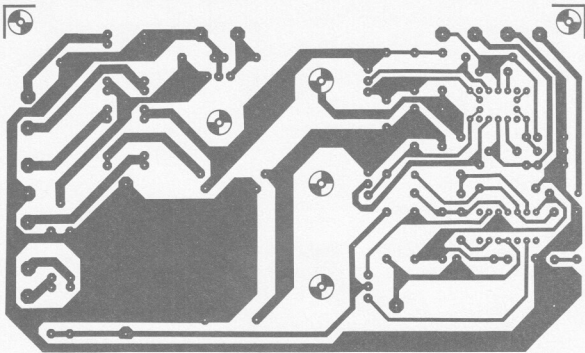

5

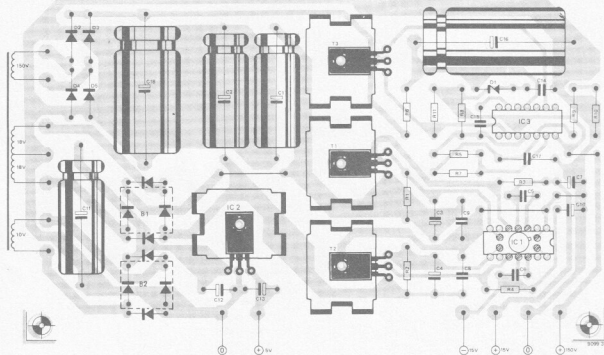

quency square-wave oscillator, block 'E', while in the alternate mode it is clocked by flyback pulses from the timebase. The timebase consists of a linear ramp generator with selectable sweep speeds, block H. To obtain a stable trace the timebase must start each sweep at the same point on the Y input waveform, and this is the function of the trigger circuit, block G. The timebase may be triggered from the output of either the Y1 or the Y2 preamplifier, or from an external trigger source. The ramp output of the timebase is fed into the X output amplifier, which is in many respects similar to the Y output amplifier.

However, the horizontal position control is incorporated in the X output amplifier, and the gain of the amplifier may be increased by a factor of five to expand the trace. The X amplifier may also be connected to the output of the Y1 preamplifier instead of to the timebase, so that the Y1 input then becomes an X input, while the Y2 preamp remains as the Y input. This avoids the necessity for a separate X input and X preamplifier, and gives the X input the same facilities as the Y input.

Flyback pulses from the timebase are used to drive the blanking amplifier, block F. During flyback the output of

this amplifier cuts off the CRT beam current so that the retrace does not appear on the screen. The blanking amplifier also has an external input for 'Z' or brightness modulation of the trace.

Power Supplies

An oscilloscope employing all solid-state circuitry must invariably use a number of different supply voltages. In the days of valves most of the circuits ran at the same (high) voltage. In a solid-state oscilloscope the X and Y output amplifiers must still operate at high voltages, as must the CRT, but it would



be prohibitively expensive to use high voltage devices throughout the circuit. Furthermore, if use is to be made of integrated circuits to simplify construction then the situation is further complicated. Many linear circuits require a ± 15 V supply, while logic circuits (TTL) require a +5 V supply. Fortunately, stabilized supplies may be constructed fairly simply using IC voltage regulators.

The low voltage sections of the power supply are given in figure 2. The ± 15 V supplies for the Y preamps, electronic switches, timebase and blanking amplifiers are derived from a centre tapped 18-0-18 V secondary winding on the

transformer. This is rectified by B1 and stabilized by a 3501 dual regulator, using external series pass transistors to increase the output current capability. The +5 V supply, which powers the logic circuits in the trigger and beam-switching sections of the oscilloscope, is derived from a single 8 V winding, the output of which is rectified by B2 and stabilized by a 5 V fixed regulator type L129. A 6.3 V winding provides the AC heater supply to the CRT.

The high-voltage section of the power supply is shown in figure 3. The X and Y output stages require a +150 V supply and this is provided by a μ A723 regulator operating in a floating mode.

Figures 4 and 5. Printed circuit board and component layout for the stabilized supplies.

Figure 6. The power supply board mounted in the chassis.

Table 1. Specifications and recommended operating conditions

manu- facturer	type	final anode voltage	focus voltage	grid voltage for cutoff	X-deflection factor (V/cm)	Y deflection factor (V/cm)	heater volts	heater amps	overall length	diameter	base
Mullard	DG7-32	500V	0-120	-50 + -100 V	37	21	6.3	0.3	170mm	70mm	B12A
	D7 -190GH	1000V	100-180	max -35V	29	11.5	6.3	0.3	225mm	75mm	special 14 pin
	D10-180GH	1500V	140-275	max -50V	32	13.7	6.3	0.3	260mm	100mm	special 14 pin
	D13-480GH	2000V	220-370	max -65V	31.3	14.4	6.3	0.3	310mm	133mm	special 14 pin
Telefunken	D7 -210	1000V	100-180	-15 + -35V	28	11.5	6.3	0.3	220mm	75mm	special 14 pin
	D13-620	2000V	220-370	-25 + -65V	28	14.5	6.3	0.3	310mm	133mm	special 14 pin

The maximum voltage between the V+ and V- pins of the 723 must not exceed 40 V, so in this application the V- pin is connected not to ground but to the stabilized output. Zener diode D1 limits the voltage across the 723 to 36 V. A series pass transistor T3 carries the output current and the difference between the unregulated input and regulated output voltages (about 75 V) is dropped across it.

The final anode (EHT) voltage for the CRT is provided from a 700 V winding on the transformer. This is rectified to give -975 V and a voltage doubler is also provided to give -1950 V as an alternative, to suit different types of tube, as will be discussed later.

WARNING

The high voltages used in the oscilloscope, especially the final anode voltage are LETHAL. Extreme caution should be used when testing these circuits. The reservoir capacitors may hold a charge for several minutes after the supply has been disconnected, especially if the power supply is not connected to the rest of the oscilloscope.

Acquisition of a transformer with such a multiplicity of secondary windings may seem to pose a problem. Fortunately a special transformer is being custom-made for the Elektroscope, and readers are advised to look out for announcements by suppliers in Elektor. Alternative transformers or combinations of transformers may be used, but the insulation between windings must be of a very high standard in view of the high voltages involved.

Construction

The four stabilized supplies are mounted on a single printed circuit board, the layout of which is given in figures 4 and 5. The EHT supply circuit is mounted on another board, together with the CRT biasing circuits and the blanking amplifier. This board will be described during the discussion of the CRT circuits.

CRT Circuits

The Elektroscope may be fitted with a variety of CRT's of the mono-accelerator type, i.e. those not having a post-deflection anode (PDA). These are the lowest cost type of oscilloscope tubes, have a relatively low final anode voltage and are simple to use, which makes

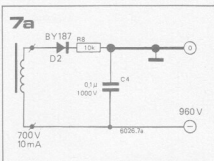
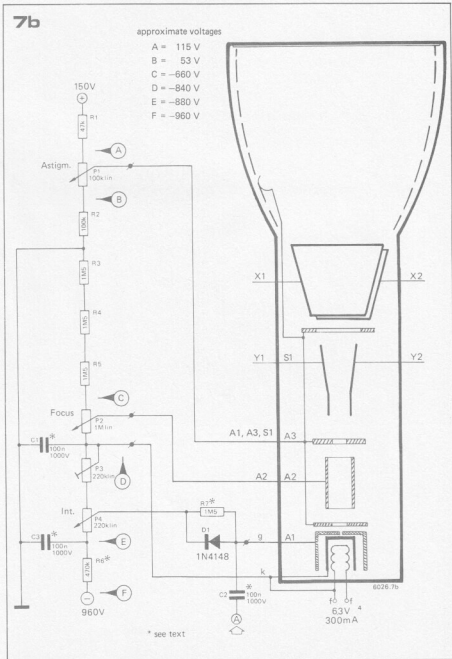

Figure 7. Biasing arrangement for CRT using 1 kV supply.

Table 1. Specifications of CRTs.

Table 2. Values of bias components for the various CRTs that may be used.



them ideal for the home-built oscilloscope. Against this, they have limitations with respect to writing speed and hence bandwidth, and many of them (especially the very cheapest ones) do not have a flat face, which can be a slight inconvenience.

Before looking at the various types of CRT and their biasing circuits it may be instructive, for the benefit of the less experienced constructor, to take a look at the general operating principles of a CRT. The CRT, as older readers may remember, is a modified form of thermionic valve. Looking at figure 7 it will be seen that the CRT possesses a heater, which heats up the cathode k, causing it to emit electrons. These accelerate through the grid g, under the influence of an electric field caused by a high potential difference between the cathode and the anode system a1 - a4. However, unlike a conventional valve the electrons do not strike the anode, but pass through the anode system to impinge on the phosphor-coated screen, causing it to glow. The electrons then leak back to the anode along a graphite coating on the inside of the CRT.

If the accelerating field were uniform the electrons would spread out due to mutual repulsion and would arrive at the screen in a diffuse cloud. However, the first three anodes are arranged to form an electron 'lens' which focusses the electrons into a narrow beam so that they form only a small spot on the screen. The 'focal length' of the lens can be altered by varying the potential difference between anode 2 and anodes 1 and 3.

A CRT also possesses X and Y plates. By applying a potential difference between these plates an electric field may be created that will deflect the electron beam either horizontally across the screen (X deflection) or vertically up and down the screen (Y deflection). The sensitivity of a CRT is quoted in terms of volts per cm of deflection. This is usually of the order of a few tens of volts per cm, so to deflect the beam over the entire screen area the X and Y amplifiers must be capable of output swings of over 100 V. The Y plates, being mounted further away from the screen, are more sensitive than X plates since, for a given deflection on the screen, the deflection angle subtended at the Y plates is less than that at the X plates.

In some CRTs a fourth anode may be present which acts as a screen between the X and Y plates. This is invariably connected internally to anodes 1 and 3 and does not affect the biasing arrangements.

As well as deflection of the beam in X and Y directions, a third form of modulation may be introduced by the grid. As in a conventional valve the beam current may be reduced by making the grid potential more negative than the cathode. This alters the brightness of the trace and is known as intensity or Z modulation.

Table 2.

type	EHT	R6	R3	R7	P3	P4	DC working voltage C1 ... C3
D7-190 & D7-210	1000 V	470 k	1M5	1M5	220 k	220 k	1000 V
D13-480 & D13-620	1000 V	470 k	1M5	1M5	220 k	220 k	1000 V
D13-620	2000 V	1M5	1M5	1M5	220 k	220 k	2000 V
DG7-32	1000 V	3M3	0	470 k	470 k	470 k	1000 V

When biasing a CRT, care must be taken as to the potential of certain parts of the tube with respect to earth. For example if the tube were operated with the anodes at +EHT voltage then the inside of the screen would be at this potential, since it is connected to the anodes by the graphite coating. This would cause a buildup of static charge on the outside of the screen, and distortion of the trace would occur if an earthed object were brought near the screen.

In addition the anodes must operate at around the same mean potential as the X and Y plates, as otherwise an electric field would exist between the anodes and the plates, giving rise to an asymmetric defocussing of the beam known as astigmatism. In the Elektroskope the X and Y amplifiers operate at an HT voltage of about 150 V, and the quiescent output voltage on the X and Y plates is about half this. The anodes thus operate at around +75 V, with the exception of A2 the focussing anode. This voltage may be varied by the astigmatism control to reduce astigmatism to a minimum. The EHT voltage is thus a negative voltage.

What does all this add up to in terms of a practical circuit? Figure 6 gives a typical biasing circuit for a CRT. The voltages may vary for different CRTs that can be used, but the principle is the same.

Anodes a1, a3 and S1 are connected to the slider of the astigmatism control, which is in the middle of a potential divider between +150 V and ground.

The voltage on the anodes may be varied between about +53 and +115 V. From ground a resistor chain R3 to R6 goes down to -EHT voltage, and the bias voltages are tapped off at various points along it. The potential on the focus anode may be varied between about -660 and -840 V by P2 and the cathode voltage is about -840 V also.

The grid potential may be taken negative of the cathode potential by P4 to vary the brightness of the trace, and there is also provision for a Z modulation input to be coupled in via C2.

Finally, the EHT voltage at point F is about -960 V. Because of the high voltage dropped across R3 and R5 three resistors in series are used instead of a single resistor, so that only about 220 V is dropped across each resistor. Capacitors C1 and C3 provide decoupling.

Choice of CRT

A variety of CRTs may be used in the Elektroskope with only minor modifications to the circuit. Different tubes may require varying final anode voltages, and may require differing bias voltages on the various electrodes. These differences can be accommodated simply by changing resistors in the bias chain and by selecting the most suitable EHT voltage (either -960 or -1950 V).

Differences in X and Y plate sensitivity may be accommodated in various ways. Firstly, there is the obvious solution of altering the gain of the X and Y amplifiers to suit different CRTs. It is also possible to alter the X and Y sensitivity of the CRT by varying the final anode voltage. Sensitivities are quoted at a given final anode voltage. Increasing the final anode voltage (taking care not to exceed the maximum) will reduce the sensitivity, while reducing the final anode voltage will increase the sensitivity. However, too great a reduction in final anode voltage may cause an unacceptable decrease in trace brightness.

The X or Y sensitivity for a given final anode voltage may be found from the following equation.

$$V_2 = \frac{S_2 \cdot V_1}{S_1}$$

where V_2 = new final anode voltage
 S_2 = new sensitivity
 V_1 = quoted final anode voltage
 S_1 = quoted sensitivity.

Choice of CRT

The original Elektroskope prototype was built using the Mullard DG7-32 tube, as this is one of the least expensive tubes on the market. However, the useful screen diameter of this tube is only 65 mm which, although it makes for a very compact instrument, does mean that the size of the trace is limited.

Those who can afford to do so may use a larger CRT, up to 13 cm diameter, but it must be remembered that the size of the finished oscilloscope will also be much greater. A CRT with a 13 cm face is also correspondingly longer than a 7 cm one, nearly twice as long (excluding expensive wide angle deflection types).

Table 1 gives details of CRTs that may be used in the Elektroskope, while Table 2 gives component values for the bias circuits. Readers may, of course,

wish to experiment with different CRTs, and to take advantage of the low-priced surplus tubes that sometimes appear on the market. However, we regret that we cannot advise on the use of any other tubes than the recommended types and the reader must satisfy himself that any other type is suitable. For CRTs using a final anode voltage in excess of 1 kV, the biasing circuit of figure 8 should be used. Since capacitors with a working voltage greater than 1 kV are rather difficult to obtain two

capacitors in series are used for the decoupling capacitors and blanking amplifier coupling capacitors C2 and C3. For CRTs with a final anode voltage of less than 1 kV the circuit of figure 7 may be used. The operation of this circuit has already been described and the operation of the circuit of figure 8 is identical. Note that for the D13-480GH and D13-620 the possibility of operation from either EHT voltage is provided.

Blanking Amplifier

Figure 10 shows the circuit of the blanking amplifier, which performs several functions. Firstly, it provides a negative drive to the CRT grid during the timebase flyback period, thus cutting off the beam current and preventing the retrace from appearing on the screen. Secondly, it provides a negative drive to the grid on the positive and negative-going edges of the chopping waveform when the oscilloscope is

Figure 8. Biasing arrangement for CRT using 2 kV supply.

Figure 9. Pin configurations of CRTs that may be used in the Elektorscope.

Figure 10. Circuit of the blanking amplifier.

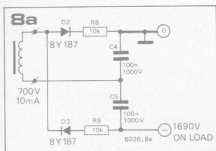

Bb

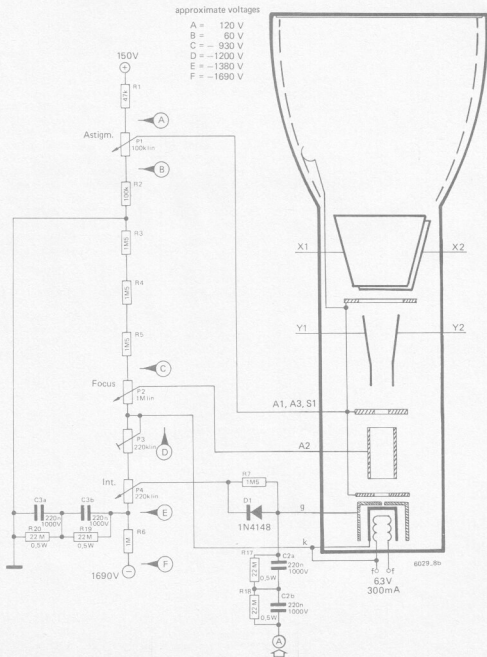

Elektroskope Specification

All figures are typical and individual instruments may vary.

DISPLAY

Choice of round CRT in various sizes.

VERTICAL DEFLECTION SYSTEM

Two identical channels, Y1 and Y2.

Bandwidth:

DC coupled: DC - 2 MHz, -3 dB

AC coupled: 3 Hz - 2 MHz, -3 dB

Sensitivity: 10 mV/Div. to 30 V/Div. in 1-3-10 steps. *

Accuracy: ± 5 %

Input Impedance: 1 MΩ/ approx. 30 pF.

Maximum Input: 400 V DC or peak AC.

DISPLAY MODES

Single Trace: Y1 or Y2.

Dual Trace: chopped or alternate modes

automatically selected depending on

timebase range. Chop rate approx.

50 kHz. Y2 trace may be displayed in

normal (positive up) or inverted mode.

X-Y mode: Y1 input may be switched

over to give X deflection while Y2 input gives Y-deflection.

HORIZONTAL DEFLECTION

Timebase: 500 ns/cm to 100 ms/cm in

1-3-10 steps.

Accuracy: ± 10 % except on 100 ms,

30 ms and 10 ms ranges.

X expansion: x5 switch gives maximum

speed of 100 ns/cm.

TRIGGER

Variable level control or automatic with bright line free run in the absence of a signal.

Source: Y1 or -

Y2 or -

external or 0

10

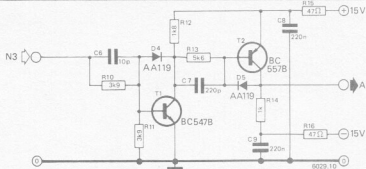

9

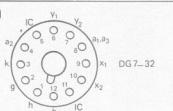

As viewed from base end
B12A base

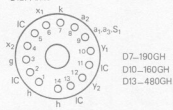

As viewed from base end
Special 14 pin base

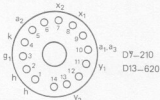

As viewed from base end
Special 14 pin base

operating in the chopped mode. This prevents a trace appearing on the screen as the beam switches between the two Y channels. The final function of the blanking amplifier is to provide an input for external Z modulation.

The blanking amplifier is, of course, not a linear amplifier but a pulse amplifier.

The input from the timebase is normally at a positive potential, transistor T1 is turned on and so is T2. During the flyback period the input from the timebase goes low, turning off T1 and T2, which provides a negative-going pulse to the grid of the CRT via C2.

Diode D1 in the CRT bias circuit acts as a clamp to prevent the grid potential exceeding the potential set by the brightness control when the output of the blanking amplifier is positive-going, as this would otherwise cause a bright-up of the trace.

When the oscilloscope is operating in the chopped mode a pulse is fed to the blanking amplifier on each positive and negative-going edge of the chopping waveform to blank out the trace during switching. However, during the flyback period this is overridden by the flyback. This will be discussed in greater detail when the timebase, trigger and switching circuits are described.

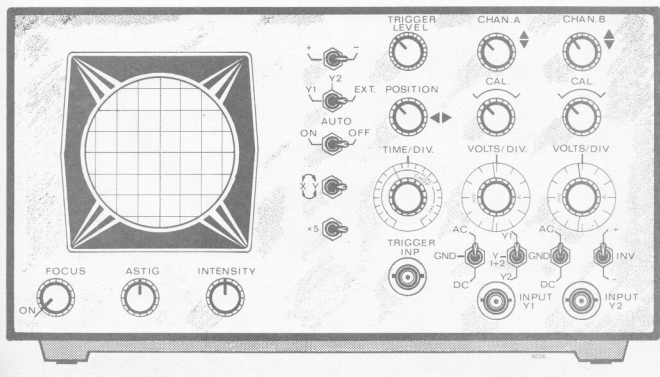

11

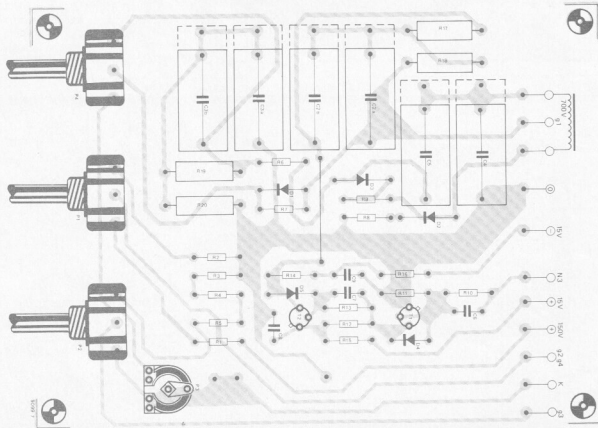
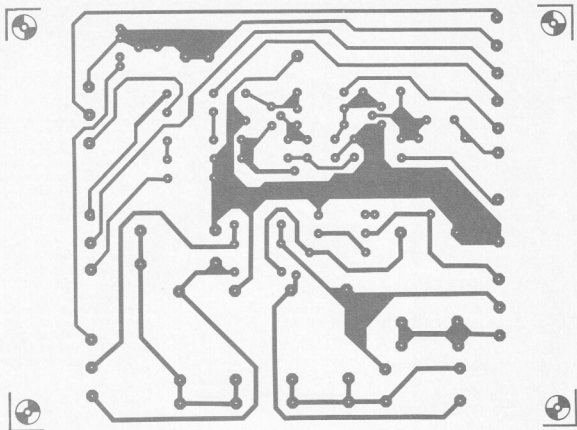

12

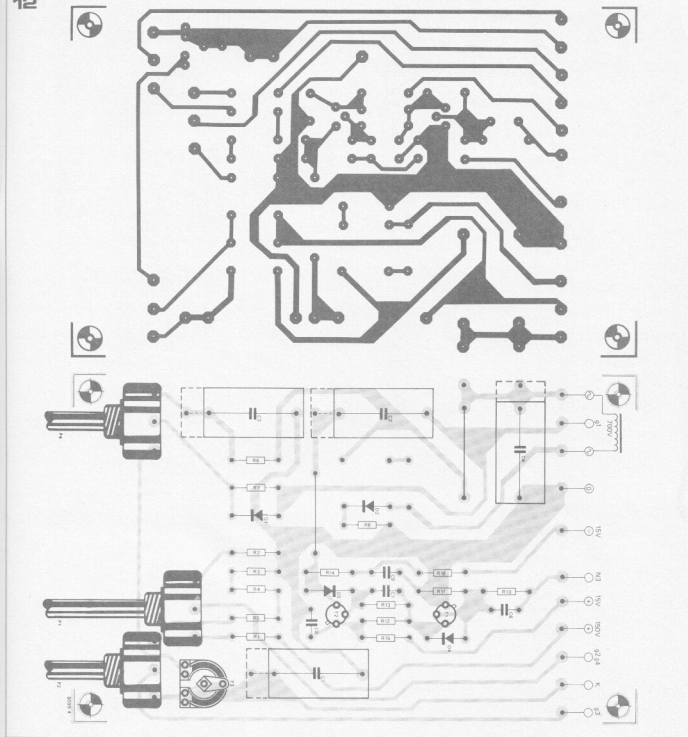

Figures 11 and 12. 2 kV and 1 kV high voltage boards. Each board can be laid out for either type of supply, but if the smaller board is used for a 2 kV supply then (rare) 2 kV capacitors must be used. The component layout shown in figure 11 corresponds to the 2 kV supply (figure 8), whereas the layout in figure 12 is for the 1 kV supply (figure 7).

Construction

The blanking amplifier is mounted on the same p.c. board as the EHT supply and CRT bias circuits. Two alternative board layouts are given. Figure 11 is intended for use with 13 cm

CRTs and the arrangement of the potentiometers matches the layout of the faceplate for a 13 cm tube, which will be available from the EPS service. The board layout of figure 12 is intended for use with 7 cm tubes, and again the layout matches the faceplate which will be available.

However, for the benefit of the experimenter provision has been made in the layout for each board to have either a 1 kV or 2 kV EHT supply, and it is essential that the board should be wired up to suit the tube to be used. Since 7 cm tubes will generally be used with a 1 kV supply no provision has been made on the smaller board for series connection of capacitors C1 to C3 to obtain a higher voltage rating. If this board is

used for a 2 kV supply then capacitors with a 2 kV rating must be obtained.

The highest voltage across any potentiometer in the bias chain is less than 200 volts, and any ordinary potentiometer of reasonable quality will withstand this voltage. However, in view of the high voltages at which the potentiometers operate with respect to ground, only types with plastic spindles should be used.

(to be continued)

Note All component lists will be given in the final part of this article.

SIRENS

Sound effects are always popular. One of the most popular effects for 'livening up' disco-shows, films, etc., is the (police) siren. The crime series on TV have taught practically everybody the difference between the European two-tone siren and the banshee wail of the American version. The circuit described here can produce either sound.

The basic principle of the siren is shown in the block diagram (figure 1). The first section is an oscillator (Astable MultiVibrator, or AMV). For the European siren, the square-wave output from this oscillator is fed direct to the control input of a Voltage Controlled Oscillator (VCO). This causes the VCO to switch to and fro between two frequencies.

For the American siren, the output from the AMV is first passed through an integrating low-pass filter. The output from this stage is something mid-way between a sinewave and a triangular wave. When the VCO is driven by this signal, the result is a close approximation to the noise made by the American cops. The complete circuit is shown in figure 2. Transistors T1 and T2 are the active elements in the AMV. With S1 in position 'E' (for European) the time-

determining elements are P1, R2, R3 and C2; P1 sets the 'switching frequency'. The time-determining elements for the American siren are P2, R3 and C2; P2 sets the 'wailing speed'. Any number of additional preset potentiometers can be added if further siren effects are required.

The main components of the integrator are P3, R10, C5 and T3. P3 sets the amplitude of the output signal from this stage, so it is used to set the difference between the highest and lowest frequency of the American siren.

Transistors T4...T7 are the active elements in the VCO. The voltage at the control input (base of T6) determines the output frequency. For the American siren, the control voltage is the output from the integrator. Since this voltage swings up and down in the rhythm of the AMV, the output from the VCO will swing up and down in the same rhythm.

The centre frequency of this wailing siren is set with P6.

For the European siren, the square-wave output from the AMV is fed direct to the VCO, causing the latter to produce two frequencies alternately. P5 sets the lower of the two, and P4 sets the difference between them — so it can be used to set the higher frequency.

The adjustment procedures for the two sirens are quite simple.

For the European siren, first set the desired switching frequency with P1. Then set the lower frequency with P5; finally, set the upper frequency with P4. The American siren is slightly more difficult to adjust. First set the 'wail speed' with P2. Then adjust P5 and P6 to get the desired effect. Note that P3 will need readjustment if the setting of P2 is altered.

If more than one American siren is to be preset, an extra switch will be required between C3 and P3, so that it becomes possible to switch in several different presets for P3.

Alternatively, normal potentiometers can be used with a calibrated scale. An almost infinite number of different sirens can then be 'dialed in'. ■

Figure 1. Block diagram of the siren.

Figure 2. Circuit diagram of the complete unit. The three switches can be coupled for ease of switching between the American and European type of siren.

Figure 3. Printed circuit board and component layout.

Resistors:

R1, R16, R17 = 2k2
 R2, R3, R5, R20 = 100 k
 R4, R7, R10 = 10 k
 R6, R8, R9, R11, R12, R13, R14 = 1 k
 R15 = 3k3
 R18 = 22 k
 R19 = 12 k
 P1, P2 = 470 k (preset)
 P3 = 100 k (preset)
 P4 = 22 k (preset)
 P5, P6 = 4k7 (preset)

Capacitors:

C1 = 22 μ /6 V
 C2 = 1 μ 5/63 V
 C3, C6 = 47 μ /16 V
 C4 = 470 μ /6 V
 C5, C8 = 4 μ 7/16 V
 C7 = 680 n

Semiconductors:

T1, T3, T8 = TUN
 T2 = TUP
 T4 ... T7 = BC547B, BC107B or equ.
 D1 ... D4 = 1N4148
 Z1 = 4.7 V/250 mW zener

Sundries:

S1 ... S3 = 3-pole, 2-way (see text)

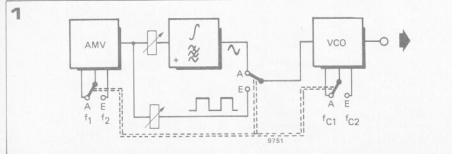

3

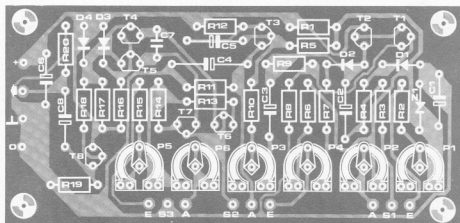
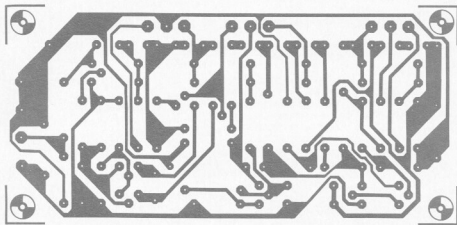

2

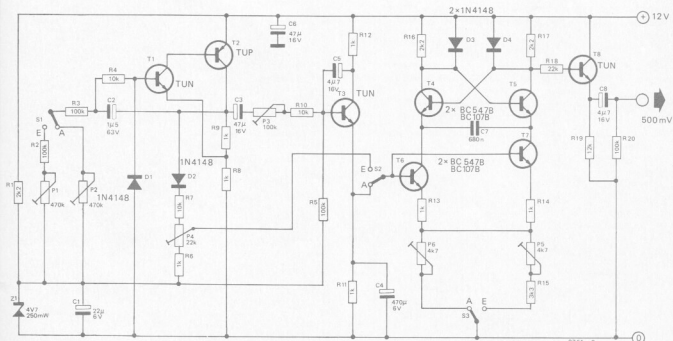



Variable persistence/ storage oscilloscope

A new variable persistence/storage oscilloscope from Hewlett-Packard includes a number of features not normally found in instruments in this price range. This new product is part of a line of low-cost scopes (the 1220 series) entirely developed and manufactured at Hewlett-Packard's European Instrument Division in Boeblingen, Germany. The model 1223A includes a burn-resistant CRT and automatic storage control to make it easy to capture low rep-rate and single-shot waveforms for stored dis-

play. The 15-MHz bandwidth and 2 mV sensitivity make it ideal in education, medical, electro-mechanical, and many other applications.

The 1223A combines the advantages of variable persistence, to integrate very-low-frequency or low-duty-cycle traces into clear displays, with the advantages of storage for single-shot events. Maximum stored writing speed is 1 cm/ μ s in the storage mode. The 1223A auto-erase mode provides repetitive single-shot displays for recurring view of traces while also making it easy to set up the instrument for capturing single-shot events. An auto-store mode allows the scope to wait for an event and capture it when it occurs for a total of at least two hours. A variable control for brightness of stored traces is included so a setting can almost always be found for optimum trace to background contrast.

The 1223A is suited for vibration and shock analysis (electromechanical), ECG/EEG/muscle reaction analysis (medical), machine design and service (X-Ray and numerical control), as well as the design of low frequency filters and circuits for integrating and differentiating (research and education).

The 1223A also includes TV sync, variable trigger holdoff, A + B modes, calibrated X-Y display, and selectable chop/alternate sweep operation. The instrument is supplied in an entirely closed metal cabinet.

Hewlett Packard, P.O. Box 349,
CH-1217 Meyrin 1 Geneva,
Switzerland

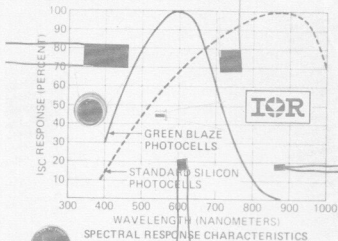
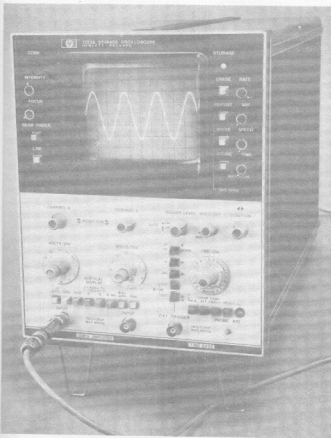

Green response photocells

A new series of green response silicon photocells has been added to the Spectra-Band series of photovoltaic devices available from International Rectifier Corporation.

The new units, called Green Blaze Photocells, are specially designed for spectral response which is greatest in the green portion of the visible spectrum. The spectral response of the units resembles a broadened photopic curve, with a maximum response in the vicinity of 556 nanometers. Applications of the Green Blaze units are chiefly in photographic, photometer and visible band insulation measurement equipment. Temperature coefficient in the short circuit current operating mode is 0.2 percent per degree C, and operating temperatures for the new units are between -40 and +125 degrees C.

The new photocells are designed for long term stability to ensure less than ± 2 percent drift in current response over a period of two years. Units are available in standard optoelectronic cases or in custom packaging or assemblies at the customer's option.

Price for standard 1 cm x 1 cm Green Blaze Photocells is about \$ 3.25 in quantities of 1,000.

International Rectifier Corp.,
233 Kansas Street, El Segundo,
California 90245, U.S.A.

Digital clock

A miniaturized electronic digital clock movement with a bright LED display showing numerals .84 inch high is now available in quantity from National Semiconductor.

The model "MA1010" series electronic clock modules, which include a large-scale monolithic MOS integrated circuit, power supply and other discrete components on a single printed circuit board feature a four-digit .84 inch Light Emitting Diode (LED) display. According to national, this represents a larger numeric dis-

play than on any digital clock module previously manufactured. Another important factor is that the size of the entire module is not much larger than its display.

"It's ideal for those manufacturers who want a large numeric display but only have limited space for a clock movement. The user only needs to add a transformer and switches to construct a pre-tested digital clock for application in a clock radio, digital alarm clock or instrument panel clock. The module is also suitable for use in communications and CB base radio stations, TV and stereo systems and medical instruments. Time-keeping may be done from inputs of either 50 or 60 hertz. Display formats of 12 and 24 hours are available. Direct, non-multiplexed drive for



the LED display eliminates RF interference, which makes the module easy and economical to use in clock radios and hi-fi systems.

Features include indicators for "alarm on" and "p.m.", a blinking colon to indicate interruption of power, "sleep" and "snooze" timers, and capability for a variable-brightness control. Time-setting is made easy for the user by providing "fast" and "slow" scanning controls.

Alarm clock options include a transistor oscillator circuit that is capable of driving an 8 ohm loudspeaker, or may be used with an inexpensive earphone type audio transducer.

National Semiconductor GmbH
Industriestraße 10
D 8080 Fürstenfeldbruck
West Germany

The new Maplin Catalogue is no ordinary catalogue...

Hundreds of fascinating new lines

Several major new projects to build.

MAPLIN ELECTRONIC SUPPLIES

SUPERSONIC SAME DAY SERVICE!

QUALITY COMPONENTS FAST!!



Test Gear Section includes superior quality single-beam and dual beam OSCILLOSCOPES at remarkably low prices. These superb SCOPEX scopes are undoubtedly the best value for money around.

MULTI-CHANNEL MIXER

Projects section includes complete construction details of a professional quality MULTI-CHANNEL MIXER with modular sections for complete flexibility. Extremely low noise and distortion AND low cost.

Hundreds of photos, diagrams and illustrations

Catalogue includes a very wide range of components: hundreds of different capacitors; resistors; transistors; I.C.'s; diodes; wires and cables; discotheque equipment; organ components; musical effects units; microphones; turntables; cartridges; styli; test equipment; boxes and instrument cases; knobs, plugs and sockets; audio leads; switches; loudspeakers; books; tools - AND MANY MANY MORE.

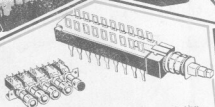

Just one of the hundreds of new lines in the component section. A new range of FULLY INTERLOCKING PUSH BUTTON SWITCHES - high quality - low price - large range.

SEND THIS COUPON FOR **YOUR** COPY OF OUR CATALOGUE ON APPROVAL! Price 50p - SEND NO MONEY NOW. Please rush me a copy of your brand new 1977/78 catalogue the instant it is published. Only if I am completely satisfied that it is worth every penny, will I send 50p within 14 days of receipt. If I am not satisfied, I may return the catalogue to you within 14 days without obligation. I understand that I need not purchase anything from your catalogue should I choose to keep it.

NAME _____

ADDRESS _____

Maplin Electronic Supplies P.O. Box 3, Rayleigh, Essex, SS6 8LR

Owing to delay in completion of larger warehouse, catalogue will be delayed by up to four weeks - so there's still time to order before publication and get your pack of ten super special offer coupons, giving big discounts on ten different popular items. **YOU COULD SAVE POUNDS! - SO DON'T DELAY - FILL IN AND POST COUPON NOW!**



* Our bi-monthly newsletter keeps you up to date with latest guaranteed prices - our latest special offers (they save you pounds) - details of new projects and new lines. Send 30p for the next six issues (5p discount voucher with each copy).

MAPLIN

ELECTRONIC SUPPLIES
P.O. BOX 3, RAYLEIGH, ESSEX SS6 8LR

Shop: 284, London Road, Westcliff-on-Sea, Essex
(Closed on Monday) Telephone: Southend (0702) 44101